



# Instruction Manual

USS-DBS47/48 Analytical Balance



## Table of Contents

1. Introduction.....	1
1.1 Safety Precautions.....	1
2. Design and Function.....	3
2.1 Components.....	3
2.2 Keyboard.....	5
2.3 Display panel.....	6
3. Installation.....	7
3.1 Unpacking and delivery inspection.....	7
3.2 Selecting the location.....	8
3.3 Installing components.....	9
3.4 Leveling the balance.....	9
3.5 Connecting the power.....	11
4. Settings.....	12
4.1 Display speed.....	12
4.2 Stability.....	13
4.3 Restore factory defaults.....	14
5. Calibration.....	16
5.1 Internal calibration.....	16
5.2 Automatic internal calibration.....	17
5.3 External calibration.....	18
6. Weighing and Applications.....	19
6.1 Weighing.....	19
6.2 Unit of weight.....	20
6.3 Counting function.....	21
6.4 Percent weighing.....	23
7. Maintenance.....	24
7.1 Precautions.....	24
7.2 Cleaning.....	25
7.3 Disposal.....	25
8. Troubleshooting.....	26
8.1 Troubleshooting.....	26
8.2 Error code.....	27
9. Technical Data.....	28

# 1. Introduction

Thank you for choosing the U.S. Solid USS-DBS47/48 Electronic Analytical Balance.

The U.S. Solid USS-DBS47/48 Electronic Analytical Balance is precise and reliable. It provides a high level of operating convenience and response sensitivity to facilitate determination of the weight of your samples. U.S. Solid's dedicated customer service staff are available to answer any inquiries regarding applications and accessories.

Please read the manual completely and follow the usage instructions before installation and operation as this will help you to make full use of the functions and performance of the USS-DBS47/48 Analytical Balance.

## 1.1 Safety Precautions

The U.S. Solid USS-DBS47/48 Analytical Balance qualifies as state-of-the-art technology and complies with all recognized safety rules. Improper use or handling, however, can result in damage and/or injury. Please follow the precautions below to ensure safe and trouble-free operation of your balance.



- The balance has a 3-pin power socket equipped with a ground terminal. To prevent electric shock and to maintain

stability in operation of the balance, be sure to ground the balance.

- Avoid getting the balance wet as it is not water resistant. Any leakage of liquid into the balance may damage the balance or cause an electric shock to the user.



- Use a power source (voltage, frequency, outlet type) adapted to the specification of the balance. If excessive voltage is used, the balance may overheat and be damaged or cause a fire.



- Operate the balance on a stable, rigid and flat table.
- Handle the balance carefully. It is a precision device, subjecting it to impact may result in a malfunction.
- If the device is not be used for a long period of time, the power should be turned off and disconnect the power cable.
- Do not disassemble, remodel or repair this product or accessories.

## 2. Design and Function

### 2.1 Components

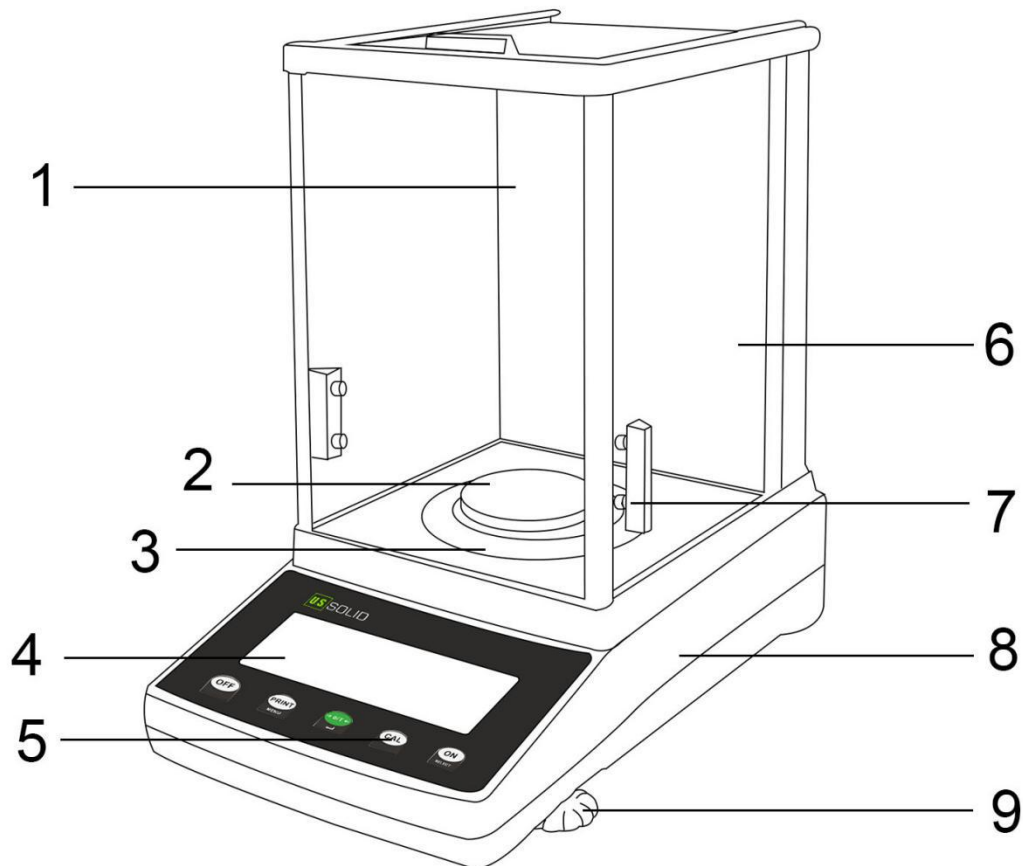

1: Weighing chamber

2: Weighing pan

3: Anti-draft ring

4: Display panel

5: Keyboard

6: Glass door

7: Handle of glass door

8: Balance main body

9: Leveling foot

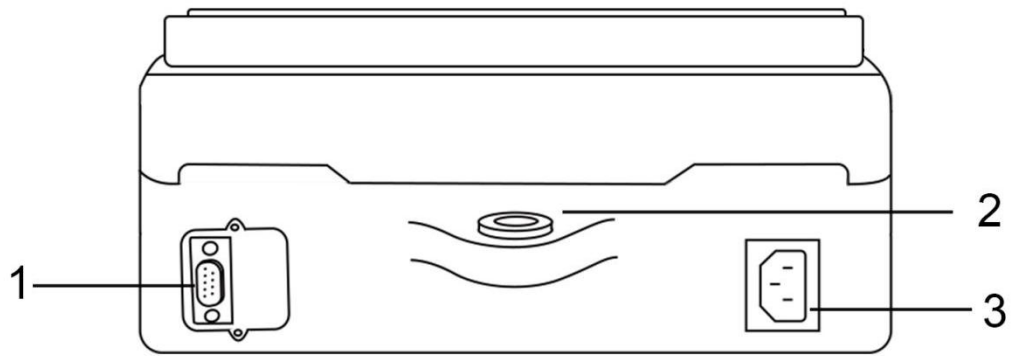





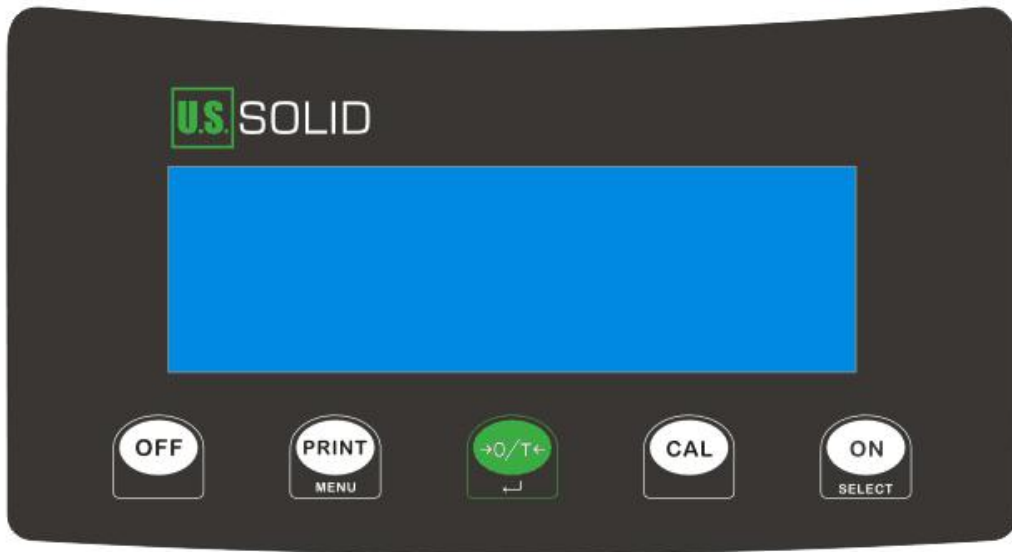

1: RS-232 connector

2: Level bubble

3: Power inlet

## 2.2 Keyboard



Key	Description
	Turn the power off
	Output the displayed values to an electronic printer, computer, or other external devices
	Tare the balance
	Select or set displayed item
	Performs automatic internal calibration
	Turn the power on
	Enter menu item selection
	Enter mode item selection

## 2.3 Display panel

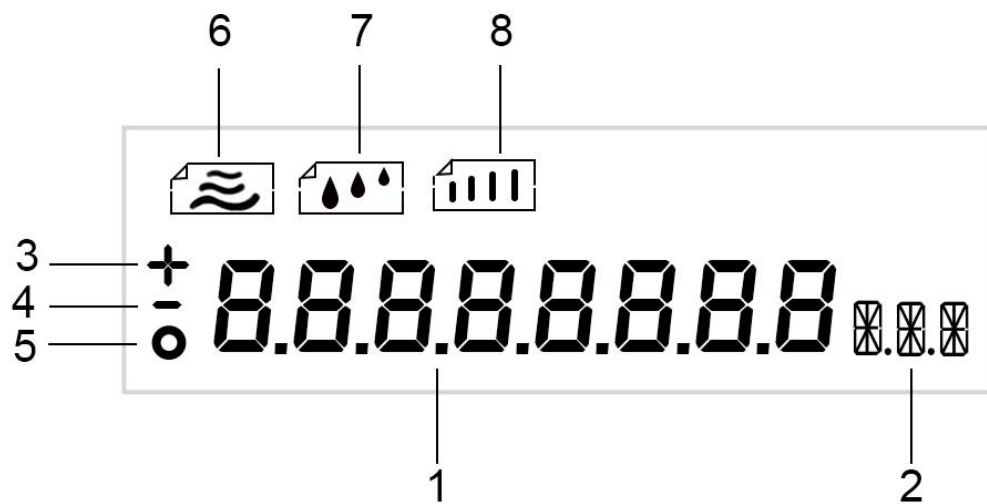

No.	Description
1	Weight value
2	Weight unit
3	Indicates positive values
4	Indicates negative values
5	Stabilization indicator
6	Display speed
7	Stability
8	Automatic calibration time mode



# 3. Installation

## 3.1 Unpacking and delivery inspection

The USS-DBS47/48 Analytical Balance is a precision instrument. Unpack the balance carefully and check the delivered items for completeness.

The following accessories are part of the standard equipment for your new USS-DBS47/48 Analytical Balance:

- 1 Balance Main Body
- 1 Weighing Pan
- 1 Draft Shield
- 1 Power Cable
- 1 Calibration Weight
- 1 Glove
- 1 Instruction Manual
- 1 Quality Certification

Check the instrument for damage in transit. Immediately inform the U.S. Solid customer service if you have any complaints or parts are missing.

## 3.2 Selecting the location

Measurement performance of your balance depends largely on the surrounding environments.

Please follow these guidelines to make sure the proper environmental conditions are met:

- Select a firm, horizontal location that is free from vibrations.
- Make sure that the ambient temperature is between 5°C and 30°C, the relative humidity is around 50% and that non-condensing conditions are met.
- Avoid direct sunlight and ensure that there are not any excessive temperature fluctuations.
- Ensure the balance is placed a sufficient distance from heat-sensitive materials in the vicinity of the instrument.
- Avoid the effects of air currents from air conditioners, ventilators, open doors, or windows.
- Keep away from objects or equipment that are magnetic or capable of generating magnetic fields.
- Surroundings should be as free from dust as possible.

### 3.3 Installing components

1. Place the balance main body on the installing location.
2. Push the side glass door open.
3. Gently attach the pan on the center axis of the weighing chamber.
4. Push the side glass door close.

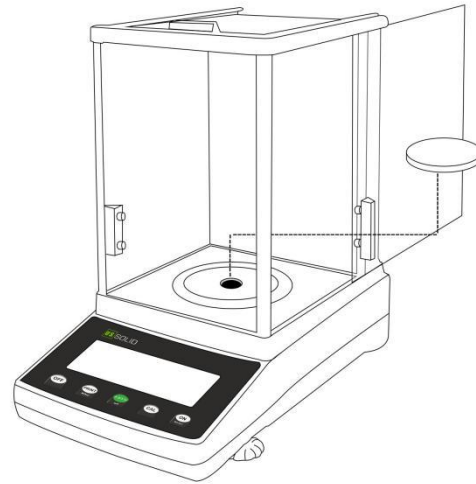

### 3.4 Leveling the balance

Accurate horizontal positioning necessary for repeatable measurements and exact results. To compensate for small irregularities or tilts at this location, the instrument needs to be leveled.

Adjust the leveling feet of the analytical balance until the air bubble in the indicator is centered. The level indicator is located under the cover towards the rear of the analytical balance.

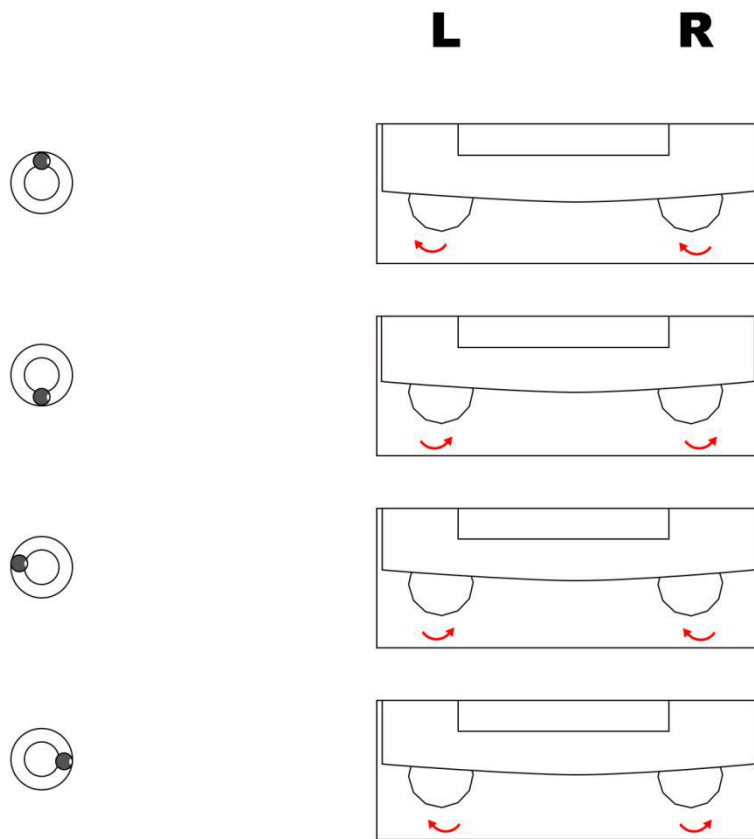

<b>Position of air bubble</b>	<b>Adjustment method</b>
up	Turn both feet clockwise
down	Turn both feet counterclockwise
Left	Turn left foot counterclockwise, right foot clockwise
Right	Turn left foot clockwise, right foot counterclockwise

## 3.5 Connecting the power

### Warning:

- To prevent electric shock, be sure to use the 3-pin power cord with equipment grounding connector.
- Check to make sure the voltage indicated on the analytical balance data label matches the local line voltage. Do not connect the balance to the power source if it does not match.

### Connecting a power cable:

- a. Insert the female end of the power cord into the power inlet located at the rear of the main unit.
- b. Plug the male end of the power cord into the outlet.

### **Note:**





To obtain accurate results, the analytical balance must be warmed up for at least one hour each time it is connected to an AC power source or after a power outage of more than 30 minutes.

Only after this length of time will the balance reach the required operating temperature.

## 4. Settings

### 4.1 Display speed

If the operating environment meets the requirements, the display speed of the balance can be adjusted to reduce the time required for the balance to stabilize, thereby improving work efficiency.

Icons	Description
	Highest speed
	High speed
	Normal speed
	Low speed

Depending on the environment in which the instrument is used, carefully select the display speed to avoid instability that might be caused by excessive speed.

1. Press the “ON” button several times in succession until the “SPEED” is displayed.

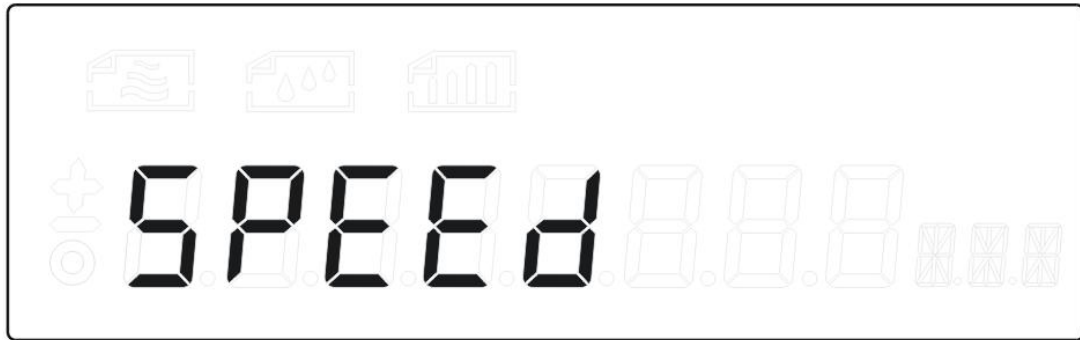





2. Press “O/T” to enter the selection of display speed mode.
3. Press “ON” to select required speed and confirm by pressing “O/T”.

## 4.2 Stability

According to different operating environments, the balance is kept in a relatively stable state by adjusting its stability.

It is recommended that the balance be adjusted appropriately in an environment that guarantees its normal operation.

Icons	Description
	Lowest stability
	Low stability
	Normal stability
	High stability

1. Press the “ON” button several times in succession until the “STAB” is displayed.



2. Press “O/T” to enter the selection of stability.
3. Press “ON” to select required stability and confirm by pressing “O/T”.

### 4.3 Restore factory defaults

If the balance is improperly set or operated, all settings can be restored to factory defaults, which will ensure that the balance is suitable for most operating habits and environments. When the balance is found to be abnormal and unstable, the stability of the balance can also be adjusted by restoring the factory settings.

1. Press the “ON” button several times in succession until the “DEFAULT” is displayed.



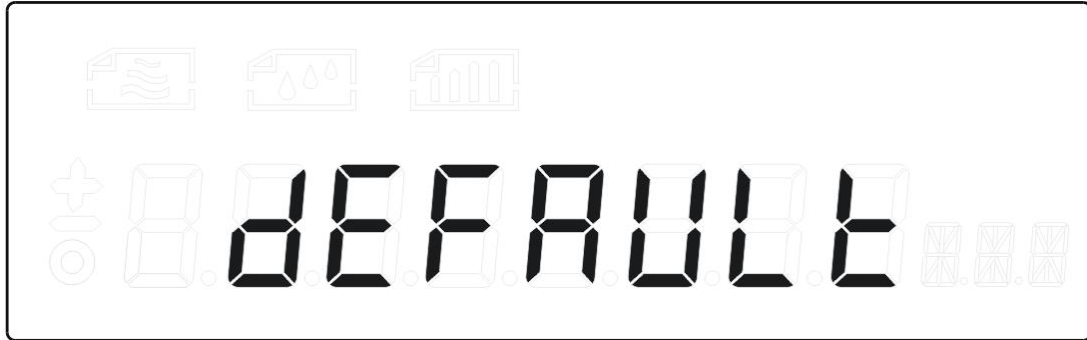

2. Press “O/T” to confirm and an audible signal will sound.



3. Then return to the splash screen, the factory defaults have been restored.

\* The setting is only applicable to situations where settings are confusing due to incorrect operation. Factory defaults should NOT be performed frequently.

## 5. Calibration

Calibration is a necessary step to assure the analytical balance will accurately weigh the sample.

Perform calibration operations in the following situations:

- Changes in the location of use (including moving in the same room).
- Changes in ambient conditions.
- Prior to each use.

The USS-DBS47/48 Analytical Balance offers three calibration methods.





### 5.1 Internal calibration

Install the balance as instructed and ensure it is sufficiently warmed-up.

When the balance is in the no-load state, press the “CAL” button and “CAL-INT” will flashing displayed. Then the balance will start automatic internal calibration. The instrument will return to weighing after calibration.

## 5.2 Automatic internal calibration

The USS-DBS47/48 Analytical Balance offers four kinds of automatic calibration time mode to choose from: “10MIN” “30MIN” “60MIN” and “OFF”. Respectively, these modes indicates that that the balance is automatically calibrated either every 10 minutes, every 30 minutes, every 60 minutes or the automatic calibration is off.

<b>Icons</b>	<b>Description</b>
	Automatically calibrate every 10 minutes
	Automatically calibrate every 30 minutes
	Automatically calibrate every 60 minutes
	Automatic calibration shut off

### Procedure:

1. Zero the balance in the weighing state.
2. Press the “ON” button several times in succession until the “AUTOCAL” is displayed.
3. Press “O/T” to confirm to enter the time mode selection state.
4. Press “ON” to select the desired time mode.

### 5.3 External calibration

The balance must be fully warmed up for one hour to stabilize the weighing before calibration.

Procedure:

1. Zero the balance in the weighing state.
2. Press the "ON" button several times in succession until the "E-CAL" is displayed.
3. Press the "O/T" button to confirm and "CAL-200" will flashing displayed.
4. Place the 200g calibration weight on the weighing pan.
5. Then "200.0000g" will be displayed. External calibration is completed.

## 6. Weighing and Applications

### 6.1 Weighing

Note: Please warm up for at least one hour and calibrate before using.

1. Zero the balance in the no-load state.
2. Open the glass door of the weighing chamber and place the weighing sample on the weighing pan, then close the glass door.
3. Wait for the display to stabilize. The appearance of the stability mark indicates a stable state.
4. Read the value displayed.

Weighing a sample that needs to be in a container:

1. Open the glass door of the weighing chamber and place the weighing container on the weighing pan, then close the glass door again.
2. Wait for the display to stabilize. The appearance of the stability mark indicates a stable state. Then press "O/T" to tare, and the displayed value will return to zero.
3. Open the glass door and place the sample(s) to be weighed in the weighing container, then close the glass door.
4. After the display stabilizes, read the value displayed.

## 6.2 Unit of weight

The USS-DBS47/48 Analytical Balance has multiple sets of weight units. The unit selection function can be used to meet the unit requirements in various usage situations.

1. Press the “ON” button several times in succession until the “UNIT” is displayed.



2. Press “O/T” to enter the selection of unit.

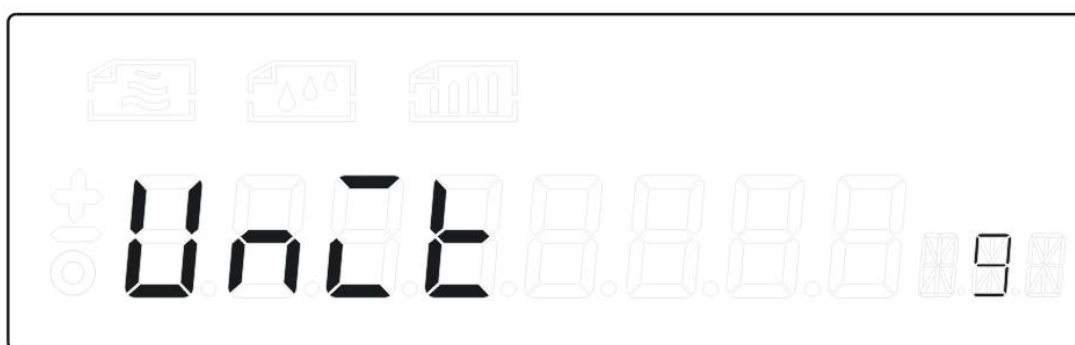

3. Press “ON” to select required unit and confirm by pressing “O/T”.

To avoid the deviation of the weighing record caused by unit misreading, please ensure that the selected unit is the one required.

## 6.3 Counting function

The U.S. Solid USS-DBS47/48 Analytical Balance has a built-in counting function that meets various industrial counting requirements, especially the counting function for small components.

To ensure the accuracy of the counting function for small components, it is necessary to ensure that the weight of all samples is consistent, and that the weight of a single object is  $\geq 0.5\text{mg}$ .

1. Press the “ON” button several times in succession until the “COU” is displayed.



2. Press “O/T” to enter the counting function, “COU 5PCS” will be displayed.



3. Press “ON” to select the quantity and put the corresponding quantity of samples. Press “O/T” to confirm and “COU ---PCS” will be displayed.



4. The operation can be started when the “COU ---” disappears and the corresponding number appears.

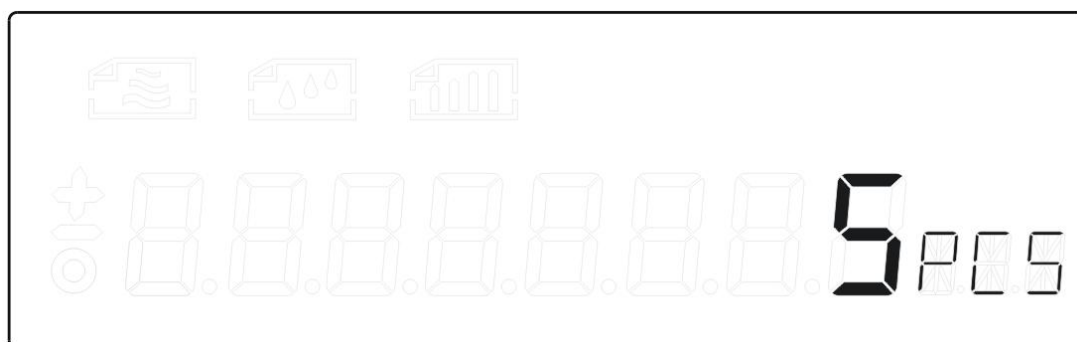

5. After the test is finished, press “ON” to select “weight”, and press “O/T” to confirm to exit and return to the weighing interface.





## 6.4 Percent weighing

The U.S. Solid USS-DBS47/48 Analytical Balance has a built-in percent weighing function.

1. Zero the balance in the weighing state.
2. Press the "ON" button several times in succession until "PCT" is displayed.
3. Press "O/T" and "PCT 100PCT" will be displayed.
4. Put the item to be used as a reference on the weighing pan and confirm by pressing "O/T".
5. "100.00 PCT" will be displayed. Then the percent weighing operation can be started.

# 7. Maintenance

## 7.1 Precautions

The U.S. Solid USS-DBS47/48 Analytical Balance is a precision mechatronics intelligent measuring instrument, which must be carefully maintained and treated.

1. Do not use sharp objects (such as pens) to click the button, use only your fingers.
2. To avoid damage to the weighing system, do not let the object fall from the height onto the weighing pan.
3. Do not expose the balance to high humidity or dusty conditions for an extended period of time.
4. When the balance is not to be used for a long time, cover it with to prevent dust from entering.
5. When weighing powder and fine particles should be done with a suitable container to prevent dust and particles from falling into the load cell below the weighing pan.
6. Wear a glove when calibrating with the calibration weight. Do not touch the calibration weight directly with your hand.
7. Keep the balance clean and dry.

## 7.2 Cleaning

- Turn off the power switch and remove power cord during maintenance.
- Make sure that no dust or liquid enters the balance housing.
- Do not use any aggressive cleaning agents (solvents, abrasive cleaning agents, etc.) or organic solvents to clean the balance.

***Clean the balance using a piece of lint-free cloth which has been wet with a mild detergent (soap) only.***

Removing the sliding glass doors for cleaning:

1. Remove the pan and anti-draft ring from the weighing chamber.
2. Unscrew and remove the inside knob on the glass door.
3. Slide the glass door out backwards.

## 7.3 Disposal

Disposal of equipment and packaging must be carried out by the operator in accordance with relevant laws of the country or region in which the equipment is to be used.

# 8. Troubleshooting

## 8.1 Troubleshooting

**Problem:** Display remains off after switching on.

**Possible causes:**

- Power cord is not connected
- Power line fuse blown
- Power transformer damaged
- Instrument faulty

**Problem:** Weight display is constantly changing or unstable.

**Possible causes:**

- The sample pan is in contact with the draft shield or heating chamber
- Glass draft shield is not closed
- Test bench vibration
- Electromagnetic field interference
- Power supply instability

**Problem:** Displayed value and actual weight are not consistent.

**Possible causes:**

- Not calibrated before weighing
- Not returned to zero before weighing
- Balance not leveled well

## 8.2 Error code

<b>Error code display</b>	<b>Description</b>
Err.	Calibration operation error
Err. 1	Counting setting error
Err. 2	The weighing pan is not placed correctly
Err. 3	Sample weight exceeds range

## 9. Technical Data

<b>Model</b>	<b>USS-DBS47</b>	<b>USS-DBS48</b>
Capacity	120 g	220 g
Readability	0.0001g (0.1mg)	
Repeatability	±0.0002g	
Linearity deviation	±0.0003g	
Stabilization time	Within 3 seconds	
Operating temperature	63.5°F - 72.5°F ( 17.5°C - 22.5°C )	
Pan size	Φ 80mm	
Interface	RS232	
Power	110V 60Hz AC	
Dimensions	340×215×350 mm	
Net weight	6.5kg	
Shipping weight	10.0kg	

## **Contact**

Feel free to visit our website: [www.ussolid.com](http://www.ussolid.com)

You can email us at [service@ussolid.com](mailto:service@ussolid.com)

You can call one of our friendly customer service representative at

+1(800) 209-4177