

Ultrasonic Cleaner



This manual shall be made available to all users of ultrasonic cleaners. To ensure the best results and maximum durability of this U.S. SOLID LLC (hereafter U.S. SOLID or The Company) product, read and follow all instructions carefully. Failure to do so may lead to serious bodily injury and catastrophic damage to the cleaner, supplies, or surrounding area. All safety suggestions must be followed closely, and precautions must be taken to guarantee this ultrasonic cleaner is only used by qualified personnel who have understood this guide.



Contents

I. Operating Principles	1
II. Getting Started	2
III. Safety Instructions	3
Digital Ultrasonic Cleaner	
IV. Specification of Digital Ultrasonic Cleaner	6
V. Product Structure of Digital Ultrasonic Cleaner	8
VI. Operation of Digital Ultrasonic Cleaner	10
Mechanical Ultrasonic Cleaner	
VII. Specification of Mechanical Ultrasonic Cleaner	18
XIII. Product Structure of Mechanical Ultrasonic Cleaner	19
IX. Operation of Mechanical Ultrasonic Cleaner	19
X. Applications	19
XI. Troubleshooting	19

I. Operating Principles

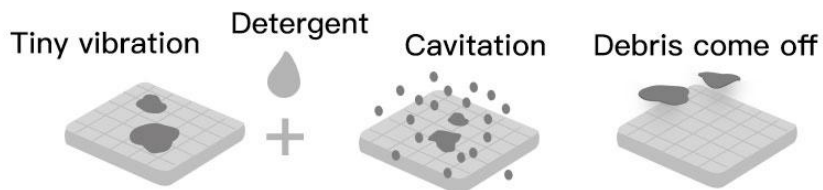
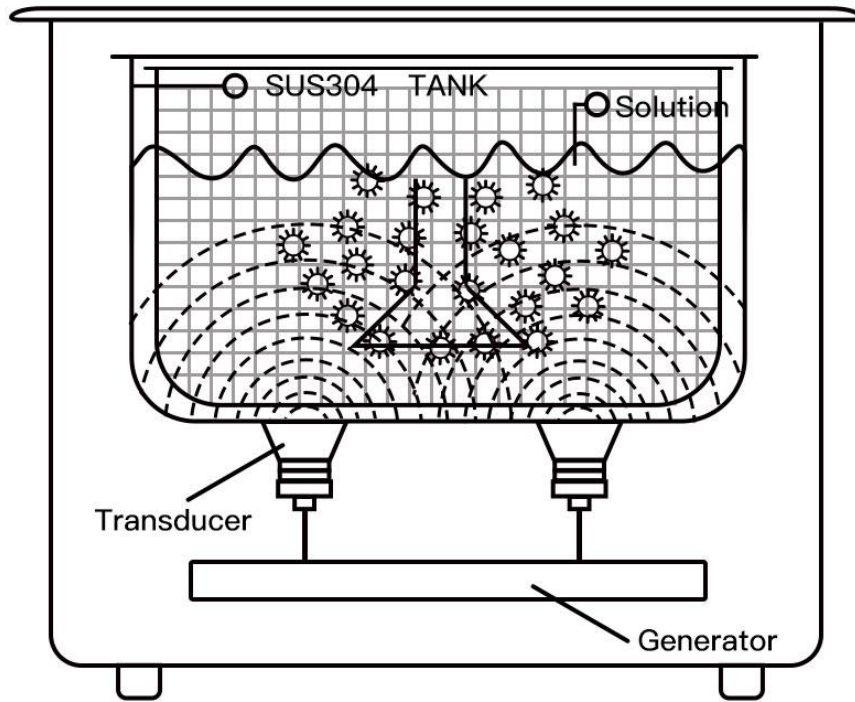

Transducers at the bottom of the ultrasonic cleaner generate intense high-frequency sound through the solution in the tank inducing cavitation in liquid. As the cavitation bubbles collapse, high shearing energies work in all directions, attacking every surface and invading all recesses and openings to remove stains or debris on objects.

II. Getting Started

Thank you for purchasing the U.S. SOLID ultrasonic cleaner. To ensure smooth and safe operations, please review this full manual for a better working experience.

Changes in technology happen often and rapidly, which is why our team at U.S. SOLID reserves the right to modify the specifications and procedures for this ultrasonic cleaner immediately and without notice. The Company will not assume responsibility for equipment damage or malfunction due to improper operation, incorrect repairs, or use of unauthorized parts.

You have 30 days from the date of delivery to return this product. A 15% restocking fee will be applied if the returned item has been opened. We provide a 12-month warranty from the date of the sale, and we are responsible for any replacement parts caused by quality issues within the warranty window. If you want to return a defective item, please contact our customer service team to receive a free prepaid shipping label for your return. To expedite the warranty process, please describe the issue and include the following information: purchase date, order number, name of the original purchasing entity, delivery address, and serial number. After the 12-month warranty period, we offer to replace parts at the current retail cost, but complete product returns will not be accepted.

The warranty will only be in effect if all instructions in the manual are followed. The warranty does not cover damage caused by force majeure (e.g., natural disasters such as hurricanes, floods, or earthquakes).

This manual includes basic safety precautions, installation, operation, and maintenance instructions.

III. Safety Instructions

Before using your Ultrasonic Cleaner, please read and understand these safety precautions thoroughly. Failure to follow them may result in serious personal injury or property damage. Keep the unit away from children!

To avoid electrical shock:

- Always make sure the machine is grounded. Do not remove the grounding prong on the line cord plug.
- Do unplug from the power source before filling or emptying the tank.
- Do keep the control panel and the area around the cleaner clean and dry—wipe up the solution that spills over the tank brim. Water and high voltage can cause electrical shock.
- Do NOT disassemble your machine—high voltage inside the cleaner is dangerous.
- Never immerse the cleaner or power cord in water or other liquid. DO NOT touch the unit if the machine has fallen into the water during operation. Remove the power plug from the socket first.
- Do NOT handle electric appliances with wet hands.

To prevent personal and/or property damage:

- Do use water-based solutions.
- Do not use alcohol, gasoline, flammable solutions, or chlorine bleach. Doing so could cause a fire or explosion and will void your warranty. Use only water-based solutions.
- Do NOT touch the stainless-steel tank or cleaning solution—they may be hot.
- Do NOT allow the fluid temperature to exceed 80° C (176° F).
- Do NOT place your fingers or hands into the tank while the cleaner operates. Doing so may cause discomfort and possible skin irritation. Avoid contact with solutions and provide adequate ventilation.
- Please cover the tank with the lid to reduce noise and take care to avoid the hot water and steam to prevent burning your skin while removing the lid.

III. Safety Instructions

- Do NOT use the machine where the following conditions exist:
 - A place where there are extreme temperature changes,
 - A place where there is high humidity that causes condensation,
 - A place where there is strong vibration that could cause the cleaner to fall,
 - A place where there are corrosive gases or dust,
 - A place where water, oil, or chemicals may splatter, or
 - A place where there are explosive and flammable gases.

To prevent damage to the cleaner:

- Do NOT cover vents on the cover. Keep the area around the machine clean and free of debris. Place the ultrasonic cleaner on a stable and level surface. DO NOT place the device on a soft surface where the vents could be blocked.
- Do NOT ever use mineral acids as these could damage the tank.
- Do NOT run the machine CONTINUOUSLY for longer than 30 min. Running the cleaner for an extended time will cause temperature increases and damage the tank and transducers.
- Do keep the lid on during and after use which will prevent splashing and reduce evaporation of the fluid.
- Only use original parts from the manufacturer to ensure your safety and the best product performance.
- Ensure the power switch is placed in the O position (OFF) before starting.
- Do not operate when the tank is empty, or damage to the ultrasonic generator will occur. The liquid volume must be over the 2/3 line if heating is functioning.
- Do not relocate the machine while fluid is in the tank to prevent overflowing.
- The maximum running time for a single cycle is 30 minutes. Always allow a rest time of 20 minutes between cleaning cycles.
- DO NOT drop any item into the tank, as this may cause damage to the transducer. Always place items gently into the basket. Never set parts directly on the tank.
- Upon completion of the cleaning process, unplug the machine. Always clean the tank with a cloth after use.

Digital Ultrasonic Cleaner

IV. Specification of Digital Ultrasonic Cleaner

Model	USS-UC01	USS-UC02	USS-UC03
Frequency	40 kHz	40 kHz	40 kHz
Transducer	1	2	3
Capacity	2 L (0.5 gal)	3 L (0.8 gal)	6.5 L (1.7 gal)
Tank size	15*13.5*10 cm (5.9*5.3*3.9")	23.5*13.5*10 cm (9.3*5.3*3.9")	30*15*15 cm (11.8*5.9*5.9")
Unit Size	17.5*16*21 cm (6.9*6.3*8.3")	26*16.5*22.5 cm (10.4*6.5*8.7")	37.5*18*27.5 cm (12.8*7.1*11")
Unit Weight	2.22 kg (4.89 lb)	3.31 kg (7.30 lb)	5.5 kg (12.13 lb)
Heating Power	100 W	100 W	200 W
Ultrasonic Power	80 W	120 W	180 W
Working Time	0-30 min	0-30 min	0-30 min
Max. Heating Temperature	80°C (176°F)	80°C (176°F)	80°C (176°F)
Package Dimension	25.5*24*26.5cm (10*9.5*10.4")	34*24.5*31 cm (13.4*9.7*12.2")	41*25.5*35.5 cm (16.1*10*14")
Package Weight	2.62 kg (5.68 lb)	3.83 kg (8.44 lb)	6.2 kg (13.67 lb)
Drainage	N/A	N/A	√

IV. Specification of Digital Ultrasonic Cleaner

Model	USS-UC04	USS-UC05	USS-UC06
Frequency	40 kHz	40 kHz	40 kHz
Transducer	4	6	10
Capacity	10 L (2.6 gal)	15 L (4 gal)	30 L (5.3 gal)
Tank size	29.8*23.5*15 cm (11.7*9.3*5.9")	32.5*29.8*15 cm (12.8*11.7*5.9")	50*29.8*20 cm (19.7*11.7*7.9")
Unit Size	37.5*26.5*27.5 cm (14.8*10.4*10.8")	40.3*32.5*27.3cm (15.9*12.8*10.7")	57.5*32.3*33 cm (22.6*12.7*13")
Unit Weight	7.4 kg (16.31 lbs.)	8.8 kg (19.40 lbs.)	13.4 kg (29.54 lbs.)
Heating Power	200 W	300 W	500 W
Ultrasonic Power	240 W	360 W	600 W
Working Time	0-30 min	0-30 min	0-30 min
Max. Heating Temperature	80°C (176°F)	80°C (176°F)	80°C (176°F)
Package Dimension	43.5*36*35 cm (17.1*14.2*13.8")	46*41*34 cm (18.1*16.1*13.4")	68*45*38.5 cm (26.8*17.8*15.2")
Package Weight	8.3 kg (18.30 lbs.)	9.6 kg (21.16 lbs.)	15 kg (44.07 lbs.)
Drainage	√	√	√

V. Product Structure of Digital Ultrasonic Cleaner

USS-UC01, USS-UC02

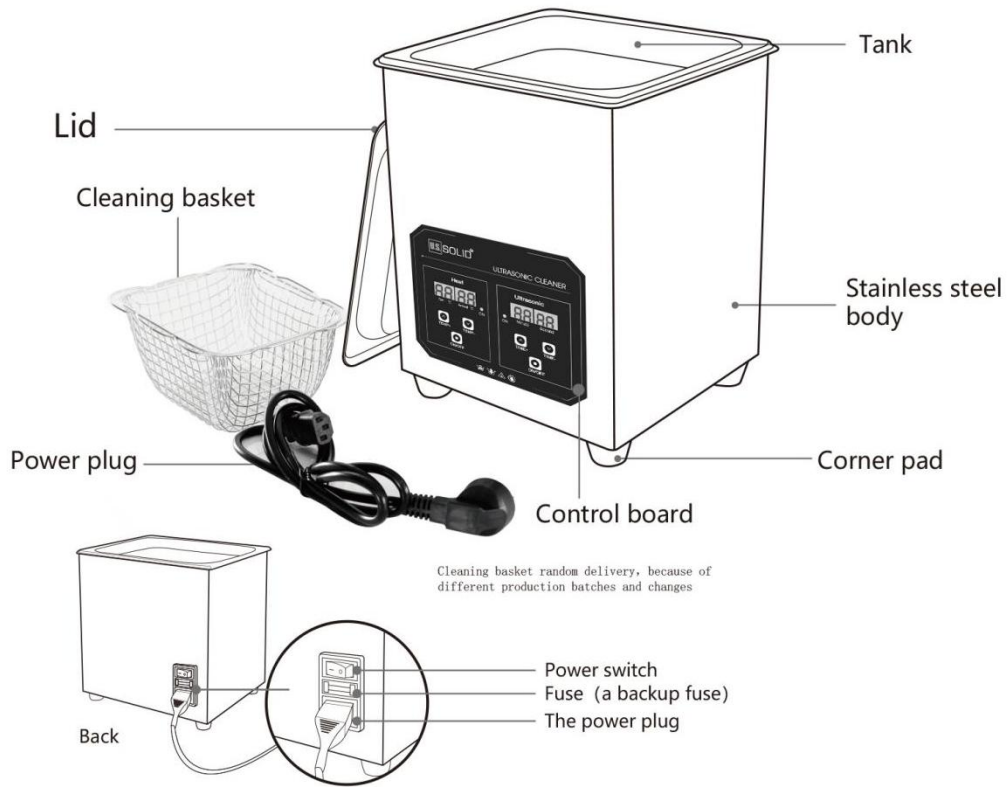

For questions or concerns, email: service@ussolid.com

V. Product Structure of Digital Ultrasonic Cleaner

USS-UC03, USS-UC04, USS-UC05, USS-UC06

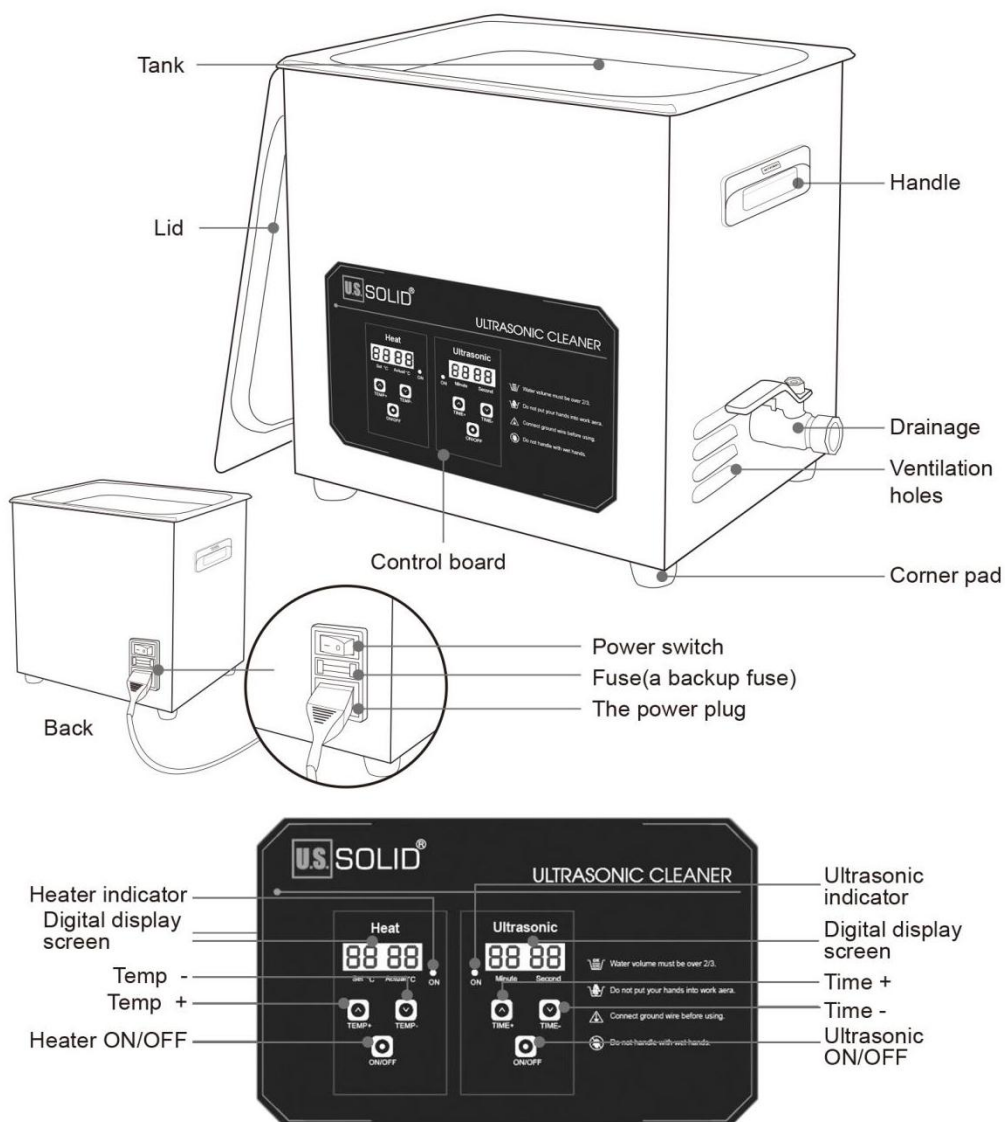

VI. Operation of Digital Ultrasonic Cleaner

Preparation

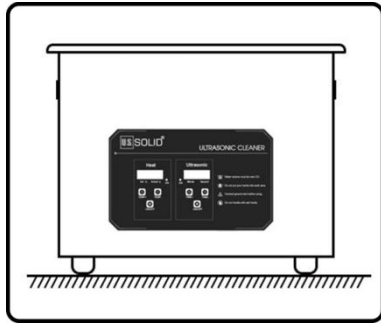

1. Place ultrasonic cleaner on a flat, stable surface.

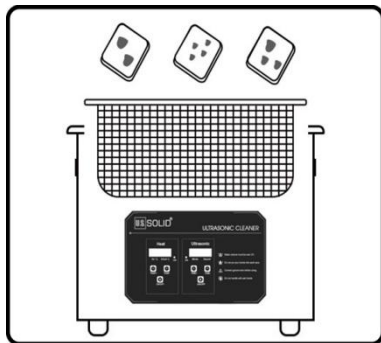

2. Put items to be cleaned inside the basket and gently place the basket inside the tank. **DO NOT PLACE THE ITEMS** directly on the bottom of the tank.

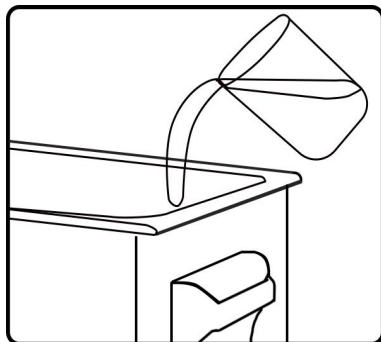

3. Add solution according to the object to be cleaned. Ensure that the volume of the solution is over 2/3 when the heating is on. **It is forbidden to heat if you use flammable liquids because prolonged vibration will increase fluid temperature, which may lead to a fire.**

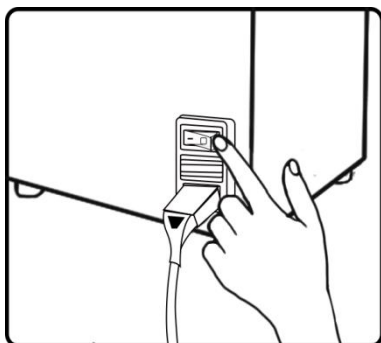

4. Plug the cleaner into a grounded outlet. Click the power switch at the back. "O" is off, and "-" is on.

VI. Operation of Digital Ultrasonic Cleaner

Set working time and temperature

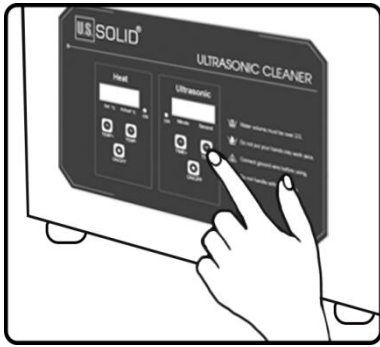

1. Press TIME+ to increase working time and TIME- to shorten the working process by 1 minute. Press ON/OFF, then the ultrasonic indicator turns red, and the machine starts working. Meanwhile, the timer begins to count down, and the cleaner will automatically stop working when the time reaches 00:00.

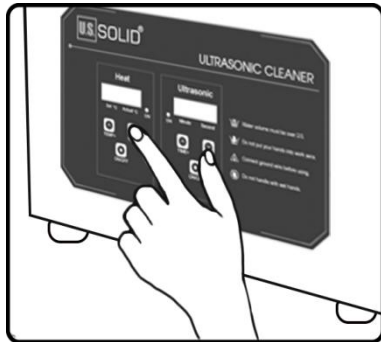

2. Once the cleaner is turned on, the indicator shows room temperature; press TEMP+/TEMP- to increase/decrease temperature. The temperature indicator shows the setting and actual temperature when the heater is working, and the heater indicator goes off when the actual temperature reaches the set temperature.

Unplug the machine

Press ON/OFF to stop working, unplug the machine, empty the tank, and clean the unit with cloth for subsequent use.

Mechanical Ultrasonic Cleaner

VII. Specification of Mechanical Ultrasonic Cleaner

Model	USS-UC11	USS-UC12	USS-UC13
Frequency	40 kHz	40 kHz	40 kHz
Transducer	1	2	3
Capacity	2 L (0.5 gal)	3 L (0.8 gal)	6.5 L (1.7 gal)
Tank size	15*13.5*10 cm (5.9*5.3*3.9")	23.5*13.5*10 cm (9.3*5.3*3.9")	30*15*15 cm (11.8*5.9*5.9")
Unit Size	17.5*16*21 cm (6.9*6.3*8.3")	26*16.5*22.5 cm (10.4*6.5*8.7")	37.5*20*27.5cm (14.7*7.8*10.8")
Unit Weight	2.4 kg (5.29 lb)	3.6 kg (7.94 lb)	5.5 kg (12.13 lb)
Heating Power	100 W	100 W	200 W
Ultrasonic Power	80 W	120 W	180 W
Working Time	0-30 min	0-30 min	0-30 min
Max. Heating Temperature	80°C (176°F)	80°C (176°F)	80°C (176°F)
Package Dimension	26*24*26.5cm (10.2*9.5*10.4")	34*24.5*31 cm (13.4*9.7*12.2")	41*25.5*35.5 cm (16.1*10*14")
Package Weight	2.62 kg (5.68 lb)	4.3 kg (9.48 lb)	6.2 kg (13.67 lb)
Drainage	N/A	N/A	√

VII. Specification of Mechanical Ultrasonic Cleaner

Model	USS-UC14	USS-UC15	USS-UC16
Frequency	40 kHz	40 kHz	40 kHz
Transducer	4	6	10
Capacity	10 L (2.6 gal)	15 L (4 gal)	30 L (5.3 gal)
Tank size	29.8*23.5*15 cm (11.7*9.3*5.9")	32.5*29.8*15 cm (12.8*11.7*5.9")	50*29.8*20 cm (19.7*11.7*7.9")
Unit Size	37.5*26.5*27.5 cm (14.8*10.4*10.8")	40.3*32.5*27.3cm (15.9*12.8*10.7")	57.5*32.3*33 cm (22.6*12.7*13")
Unit Weight	7.4 kg (16.31 lbs.)	8.8 kg (19.40 lbs.)	13.4 kg (29.54 lbs.)
Heating Power	200 W	300 W	500 W
Ultrasonic Power	240 W	360 W	600 W
Working Time	0-30 min	0-30 min	0-30 min
Max. Heating Temperature	80°C (176°F)	80°C (176°F)	80°C (176°F)
Package Dimension	43.5*36*35 cm (17.1*14.2*13.8")	46*41*34 cm (18.1*16.1*13.4")	68*45*38.5 cm (26.8*17.8*15.2")
Package Weight	8.3 kg (18.30 lbs.)	9.6 kg (21.16 lbs.)	15 kg (44.07 lbs.)
Drainage	√	√	√

VIII. Product Structure of Mechanical Ultrasonic Cleaner

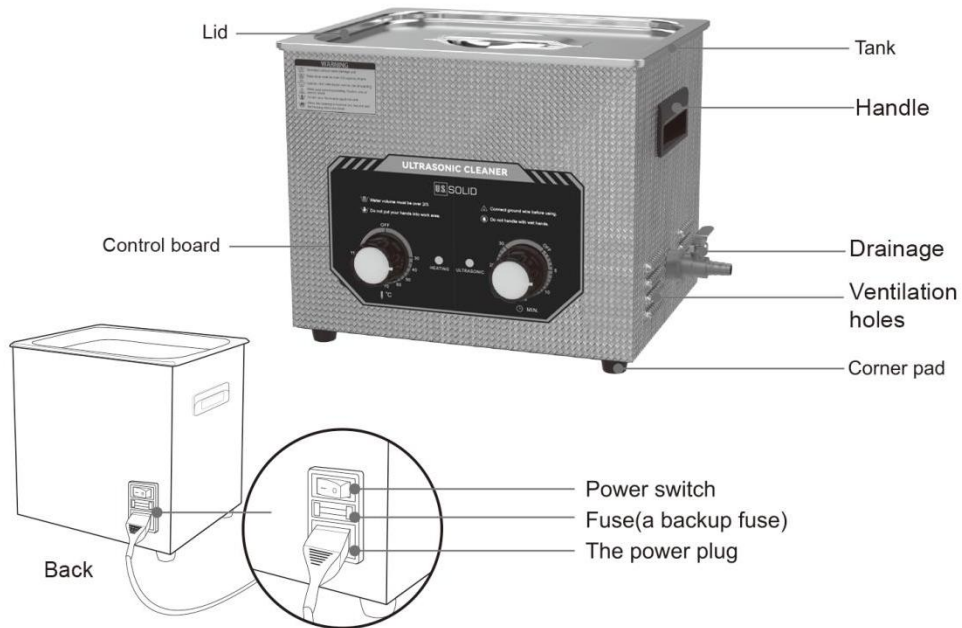

For questions or concerns, email: service@ussolid.com

IX. Operation of Mechanical Ultrasonic Cleaner

Preparation

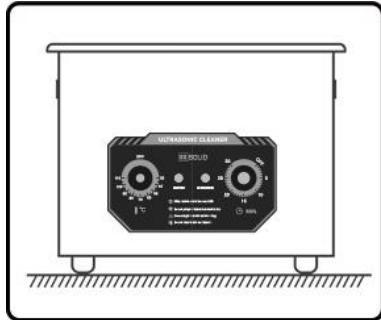

1. Place ultrasonic cleaner on a flat, stable surface.

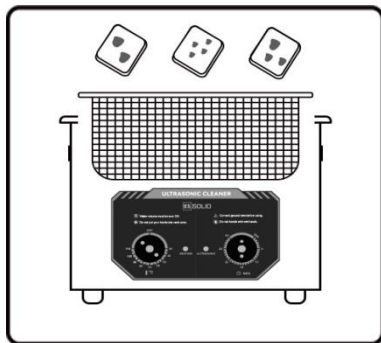

2. Put items to be cleaned inside the basket and gently place the basket inside the tank. **DO NOT PLACE THE ITEMS** directly on the bottom of the tank.

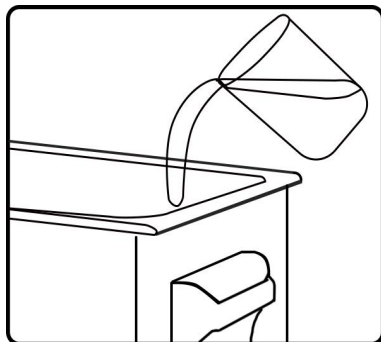

3. Add solution according to the object to be cleaned. Ensure that the volume of the solution is over 2/3 when the heating is on. **It is forbidden to heat if you use flammable liquids because prolonged vibration will increase fluid temperature, which may lead to a fire.**

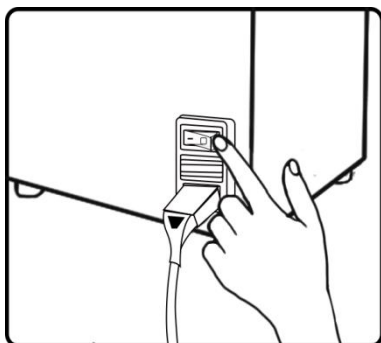

4. Plug the cleaner into a grounded outlet. Click the power switch at the back. "O" is off, and "-" is on.

IX. Operation of Mechanical Ultrasonic Cleaner

Set working time and temperature



5. Rotate the right knob clockwise to increase working time and rotate it anticlockwise to shorten the working process by 1 minute. Meanwhile the ultrasonic indicator turns red, and the machine starts working. The cleaner will automatically stop working when the knob reaches OFF.



6. Heating is an optional function of the machine. Rotate the left knob clockwise/anticlockwise to increase/decrease the setting temperature. The heater indicator goes off when the actual temperature reaches the set temperature.

Unplug the machine

Press ON/OFF to stop working, unplug the machine, empty the tank, and clean the unit with cloth for subsequent use.

X. Applications

The ultrasonic cleaner is widely used in many areas or industries. The list below are the most common industries using an ultrasonic cleaner to clean objects:

- Semiconductors
- Electrical and electronic machines
- Precision machines
- Optical devices
- Hardware and machinery parts
- Medical instruments
- Electroplating
- Car parts
- Chemical fibers

XI. Troubleshooting

Problems: No ultrasonic

Possible Causes

- A. Power supply is not connected.
- B. Fuse is broken.
- C. Cable runs into a short circuit.
- D. Transducer short circuit.
- E. PCB board is broken.
- F. Other reasons.

Solutions

- A. Connect the machine to a power supply.
- B. Change the fuse.
- C. Connect the fitted cable or replace a new one.
- D.E. F. Contact us for help.

Problem: Time control failure

Possible Causes

- A. Timer fails to work.
- B. other reasons

Solutions

- A. Replace the timer or digital control panel.
- B. Contact us for help.

XI. Troubleshooting

Problem: No heating

Possible Causes

- A. Circuit of heater doesn't connect well.
- B. Fuse burns out.
- C. Heating pad burns out.
- D. Digital display board is out of control.
- E. Other reasons.

Solutions

- A. Reconnect the plug.
- B. Change the fuse.
- C.D. E. Contact us for help.

Problem: Temperature control failure

Possible Causes:

- A. Thermostat is loosened.
- B. Thermostat tube is broken.
- C. Digital display is out of control.
- D. Other reasons.

Solutions

- A. Tighten the thermostat header.
- B. Replace thermostat.
- C. Check the broken part and change it.
- D. Contact us for help.

XI. Troubleshooting

Problem: Poor cleaning effect.

Possible Causes

- A. Liquid level is too high or too low.
- B. Temperature is too high or too low.
- C. Cleaning solution is not suitable for the object.
- D. Other reasons.

Solutions

- A. Adjust the liquid volume.
- B. Adjust temperature to optimum one.
- C. Stop the working process and unplug the machine. Replace the solution.
- D. Contact us for help.

Problem: Electric leakage

Possible Causes

The machine is not connected to a grounded socket.

Solutions

Make sure the machine is grounded.

Other problems:

Please consult our customer service.