



Instruction Manual

USS-HMA03 Moisture Analyzer



Table of Contents

1. Introduction.....	2
1.1 About Halogen Moisture Analyzer.....	2
2. Safety Precautions.....	3
2.1 Definition of Warning Symbols.....	3
2.2 Warnings.....	3
2.3 Cautions.....	5
3. Design and Function.....	6
3.1 Components.....	6
3.2 Display Panel.....	8
4. Installation and Adjustment.....	10
4.1 Scope of Delivery.....	10
4.2 Selecting the location.....	11
4.3 Installing parts.....	12
4.4 Leveling the moisture analyzer.....	12
4.5 Connect to power.....	14
5. Settings and calibration.....	15
5.1 Drying Mode setting.....	15
5.2 Ending Mode setting.....	16
5.3 Calibration.....	17
6. First Measurement.....	18
7. Maintenance.....	25
7.1 Cleaning.....	25
7.1.1 Cleaning the sample chamber.....	25
7.1.2 Cleaning the heating unit.....	26
7.1.3 Cleaning the display panel and keyboard.....	26
7.2 Disposal.....	26
8. Troubleshooting.....	27
9. Technical Data.....	29

1. Introduction

Thank you for choosing the U.S. Solid USS-HMA03 Moisture Analyzer.

The USS-HMA03 moisture analyzer is precise and reliable. It provides a high level of operating convenience and response sensitivity to facilitate determination of the moisture content of your samples. U.S. Solid's dedicated customer service staff are available to answer any inquiries regarding applications and accessories.

To make full use of the functions and performance of the U.S. Solid USS-HMA03 moisture analyzer, please read the manual completely and follow the usage instructions before installation and operation.

1.1 About Halogen Moisture Analyzer







Moisture analyzers work according to the thermogravimetric principle. Moisture is determined by the direct weight lost by the sample due to heating from an intense halogen light.

The U.S. Solid USS-HMA03 Halogen Moisture Analyzer determines the initial weight of the sample. The sample is quickly heated by the internal halogen dryer unit causing the moisture to vaporize. During the drying operation, the instrument continuously determines the weight of the sample and displays the loss of moisture. Upon drying completion, the moisture content or the dry solids content of the sample is displayed.

2. Safety Precautions

U.S. Solid Moisture Analyzer qualifies as state-of-the-art technology and complies with all recognized safety rules. Improper use or handling, however, can result in damage and/or injury. Follow the precautions below to ensure safe and trouble-free operation of your moisture analyzer.

2.1 Definition of Warning Symbols

	Electrical shock		Inflammable/explosive substance
	Hot surface		Toxic substance
	Acid / Corrosion		General hazard

2.2 Warnings



- The Analyzer has a 3-pin power socket equipped with a ground terminal. To prevent electric shock and to maintain stability in operation of the product, be sure to ground the product.

- Avoid allowing the analyzer to get wet. It is not a water-resistant structure. Any leakage of liquid into the analyzer may cause damage to the analyzer or an electric shock to the user.



- Use a power source (voltage, frequency, outlet type) adapted to the specification of the analyzer. If excessive voltage is used, the analyzer may overheat and be damaged or cause a fire.

- Do not measure samples that could cause a dangerous chemical reaction or create an explosion or poisonous gas, when the sample is dried.

- Keep flammables away from the analyzer. Parts of the analyzer become very hot. Materials placed near it might catch fire.



- Do not touch the heater cover, the halogen lamp, glass-housing, pan handle, sample pan or sample without adequate protection, burns or scalding may result.

- Parts of the analyzer are very hot when a measurement finishes. For operation, use the specified grips of the heater cover and pan handle.

Use the standard accessory tools.



- Toxic gases produced during the drying process of substances containing toxic or corrosive ingredients may cause irritation (eyes, skin, breathing), illness or death. Such substances may be dried only in a fume cupboard.



- For substances that produce corrosive vapors when heated (e.g. acids), work with small amounts of samples as the vapor may condense on cooler housing parts and cause corrosion.

2.3 Cautions



- Operate the Analyzer on a stable, rigid and flat table.
- Handle the moisture analyzer carefully. It is a precision device, subjecting it to impact may result in a malfunction.
- Ensure sufficient free space around the Analyzer as a safety zone. Allow at least 1 meter of free space above the Analyzer. Do not place anything on top of the heater cover.
- Use appropriate personal safety equipment, such as safety glasses, gloves and protective clothing.
- If an abnormal situation occurs (for example, a burning odor is smelt), remove the power cable immediately.
- When the device will not be used for a long period of time, turn the power off and disconnect the power cable.
- The Analyzer must be operated only by trained individuals who are familiar with the properties of the samples being tested and with the equipment operation.
- Do not disassemble, remodel or repair this product or accessories.

3. Design and Function

3.1 Components

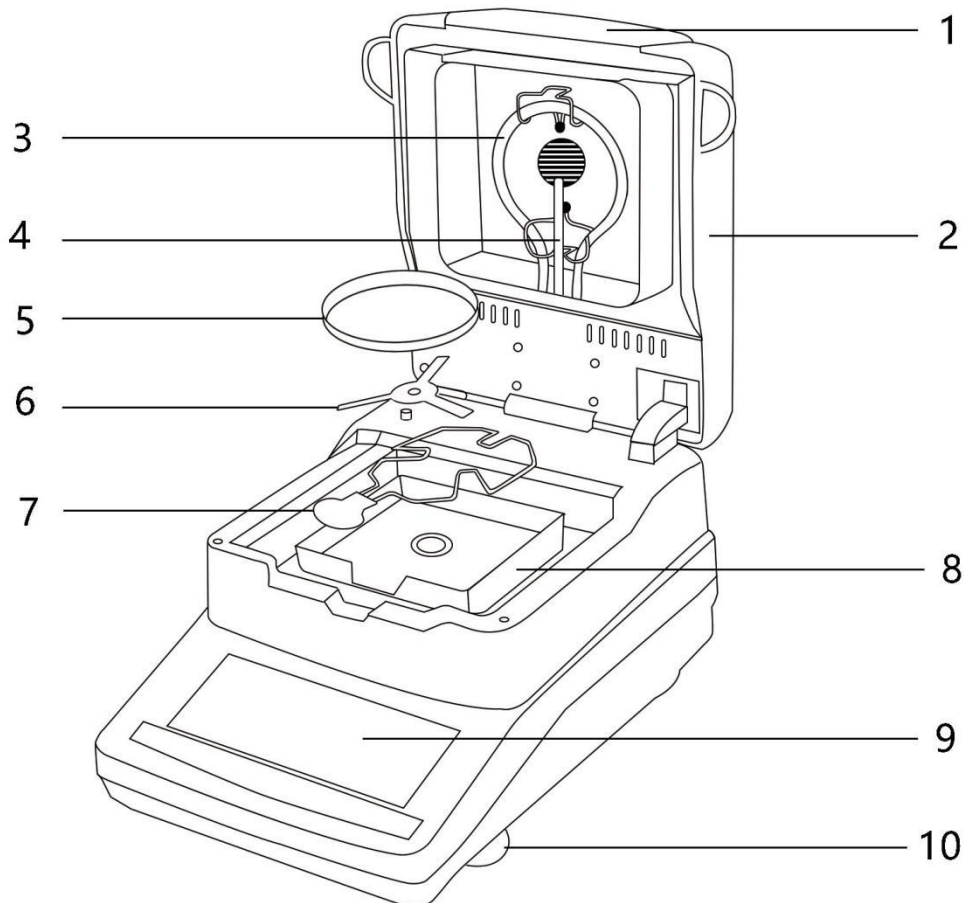

1: Observation window

2: Heater cover

3: Heater

4: Temperature sensor

5: Sample pan

6: Sample pan holder

7: Sample pan handle

8: Draft shield

9: Display panel



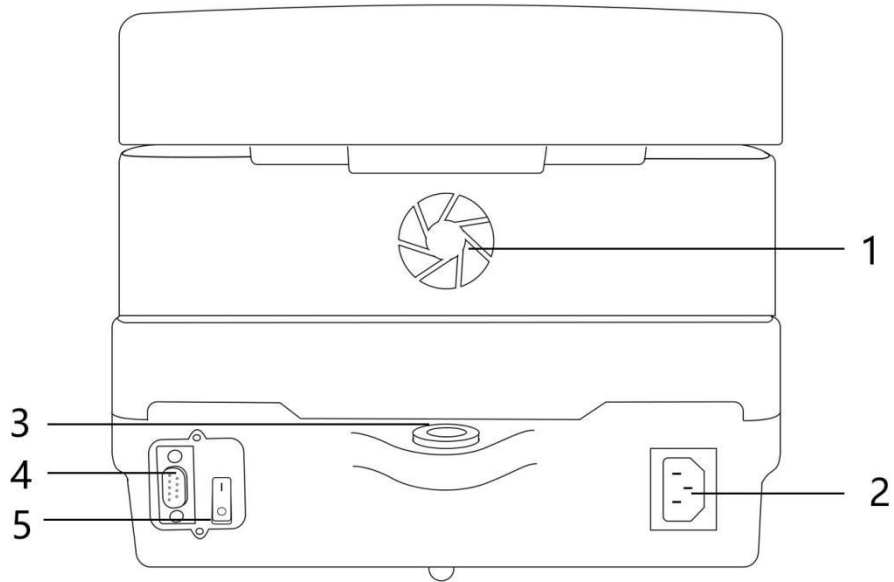

10: Leveling foot





- 1: Fan
- 2: Power inlet
- 3: Level bubble
- 4: RS-232 connector
- 5: Switch button

3.2 Display Panel



No.	Display	Name	Description
1		Setting	Set the test parameters including drying mode, temperature, ending mode and drying time
2		History	View previous test report
3		Printer	Printer Settings
4		Calibration	Weight calibration, including single point calibration and multipoint calibration
5		Language	Language selection

6		System Setting	Set time and date, touch screen calibration and factory reset
7		System	View the basic parameters of the moisture analyzer
8		Back	Return to the home page

4. Installation and Adjustment

4.1 Scope of Delivery

Unpack and check the completeness of the delivery. The following accessories are part of the standard equipment for your new Moisture Analyzer:

- 50 Aluminum Sample Pans
- 1 Sample Pan Holder
- 1 Sample Pan Handle
- 1 Draft Shield
- 1 Power Cable
- 1 100g Calibration Weight
- 1 Instruction Manual
- 1 Quality Certification

Unpacking and checking the instrument for transport damage.

Immediately inform U.S. Solid customer service if you have any complaints or parts are missing.

Note:

Keep all all of the packaging. This packaging guarantees the best possible protection for the transport of your instrument when transporting.

4.2 Selecting the location

Measurement performance of your moisture analyzer depends largely on the surrounding environments.

Follow these guidelines to make sure the proper environmental conditions are met:

- Operate the instrument only indoors.
- Make sure that all parts of the instrument reach room temperature (5°C-30°C) before switching it on. Make sure that the relative humidity is between 20% and 80% and that non-condensing conditions are met.
- The power plug must be easily accessible.
- Select a firm, horizontal location that is free from vibrations as possible.
- Avoid direct sunlight.
- No excessive temperature fluctuations.
- Surroundings should be as free from dust as possible.
- Sufficient clearance around the instrument to allow warm air to dissipate.
- Sufficient distance from heat-sensitive materials in the vicinity of the instrument.

4.3 Installing parts

Procedure:

1. Lift the cover straight up
2. Install the draft shield

Place the draft shield into the sample chamber. Align it with the hole.

3. Install the sample pan holder

Place the pan holder on the axis of the moisture analyzer main unit.

Align the pan holder with the draft shield, and insert them onto the bottom.

4. Place the sample pan handle
5. Place a sample pan

Place a sample pan on the pan holder so that the brim of the holder can secure the sample pan.

4.4 Leveling the moisture analyzer

Accurate horizontal positioning is a necessary condition for repeatable measurements and exact results. To compensate for small irregularities or tilts at this location, the instrument needs to be leveled.

Adjust the leveling feet of the Moisture Analyzer until the air bubble in the indicator is centered. The level indicator is located under the cover towards the rear of the Moisture Analyzer.

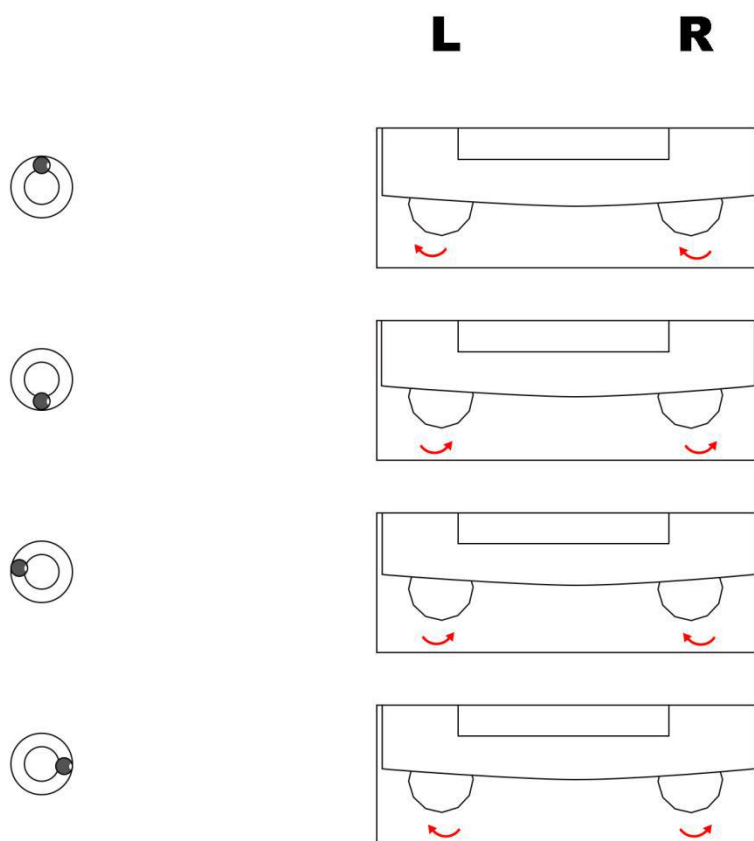

Position of air bubble	Adjustment method
up	Turn both feet clockwise
down	Turn both feet counterclockwise
Left	Turn left foot counterclockwise, right foot clockwise
Right	Turn left foot clockwise, right foot counterclockwise

4.5 Connect to power

Warning:

- To prevent electric shock, be sure to use the 3-pin power cord with equipment grounding connector.
- Check to make sure the voltage indicated on the moisture analyzer data label matches the local line voltage. If it does not match, do not connect the moisture analyzer to the power source.

Connect a power cable:

- a. Insert the female end of the power cord into the power inlet located at the rear of the main unit.
- b. Plug the male end of the power cord into the outlet.

Note:

To obtain accurate results, the moisture analyzer must be warmed up for at least 30 minutes each time it is connected to an AC power source or after a power outage of more than 30 minutes.

Only after this length of time will the analyzer reach the required operating temperature.

5. Settings and calibration

5.1 Drying Mode setting

1. Standard drying mode

This mode is the default setting and is suitable for most samples. The heating temperature can be set, the sample is heated to the set temperature during the test, and the temperature is maintained until the test ends automatically.

2. Fast drying mode

This mode is suitable for samples with high moisture content. The heating temperature can be set, and the initial temperature will exceed the set value, and will later drop to the set temperature and remain until the test ends automatically.

3. Soft drying mode

This mode is suitable for samples with low moisture content. The time required for the heater to rise to the set temperature is longer, and the temperature rises evenly and slowly. The time during the temperature rise phase can be set manually.

5.2 Ending Mode setting

1. Automatic ending mode

The test will automatically stop at a certain point in time (when the moisture content does not change within 45 seconds) in the automatic stop mode. This mode takes effect after 15 seconds of heating.

After the test is completed, the display shows the sample moisture content, heating time and current temperature.

2. Manual ending mode

The sample is in the test state and press the “START/STOP” button to terminate the test.

After the test is completed, the display shows the sample moisture content, heating time and current temperature.

Manual stop is only available in this modes.

3. Timing ending mode

Preset an analysis time, the heating will stop automatically when the specified length of time is reached.

5.3 Calibration

Weight calibration is the correction of the difference between the measured value displayed and the true weight (mass) of a sample, or the reduction of the difference to a level within specified permissible error limits.

Procedure:

1. Click “MENU” on the homepage, then click “CALIBRATION” to perform the weight calibration operation.
2. Click the “Single point calibration” icon.
3. Wait until the value (“100.000”) of the desired adjustment weight flashes and “please out on weight” displayed.
4. Put the calibration weight carefully into the center of the sample pan, “100.000” should stop flashing and “please waiting” displayed.
5. Wait until “please take away the weight” displayed, remove the calibration weight.
6. Wait until the page returns to the home page, the calibration is completed.

6. First Measurement

Steps to carry out your first measurement:

1. Turn on the switch button on the back of the moisture analyzer, the home page will be displayed.



2. Click the "MENU" icon to enter the page of settings and functions.



3. Click the “SETTING” icon to start the mode selection and parameter settings.



4. Click the “DRYING MODE” icon to select the required drying mode and confirm by clicking “CONFIRM”.

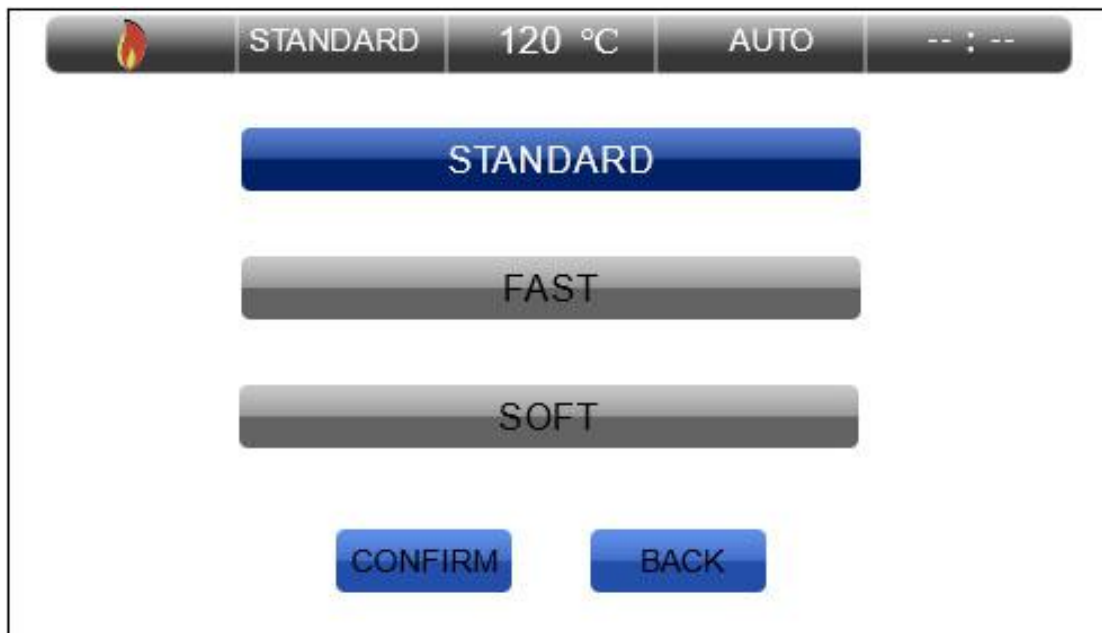

5. Click the “TEMPERATURE SETTING” icon, then use “^” or “v” to select a drying temperature and confirm by clicking “CONFIRM”.

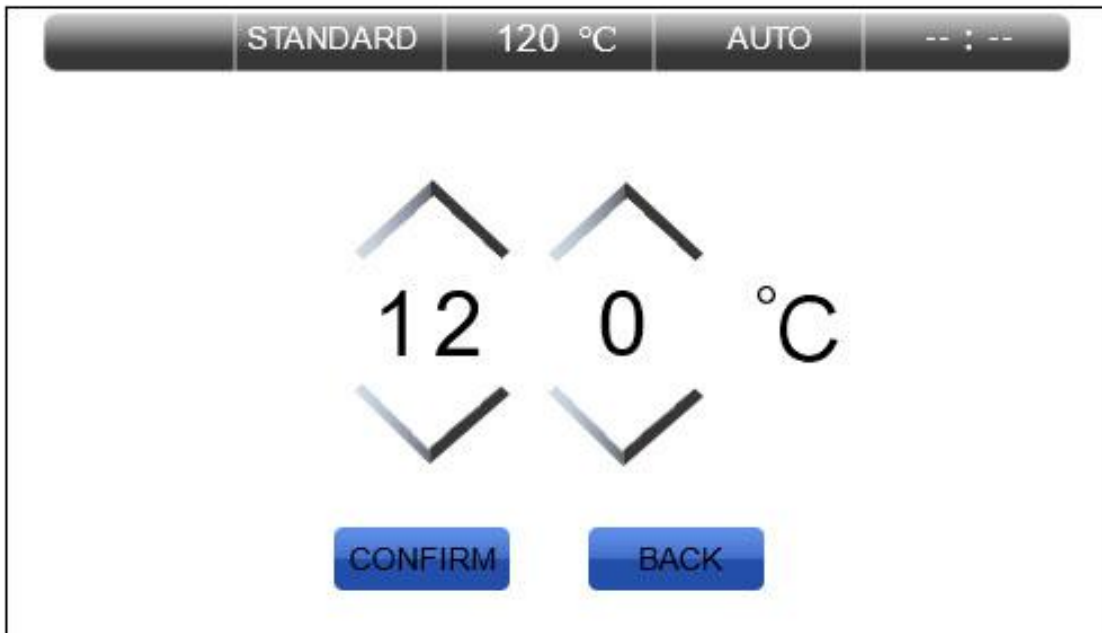

6. Click the “ENDING MODE” icon to select the required ending mode and confirm by clicking “CONFIRM”.



7. If timing ending mode is selected, then it is needed to click “TIME SETTING” icon to set a drying time. Use “^” or “v” to select required drying time and confirm by clicking “CONFIRM”.

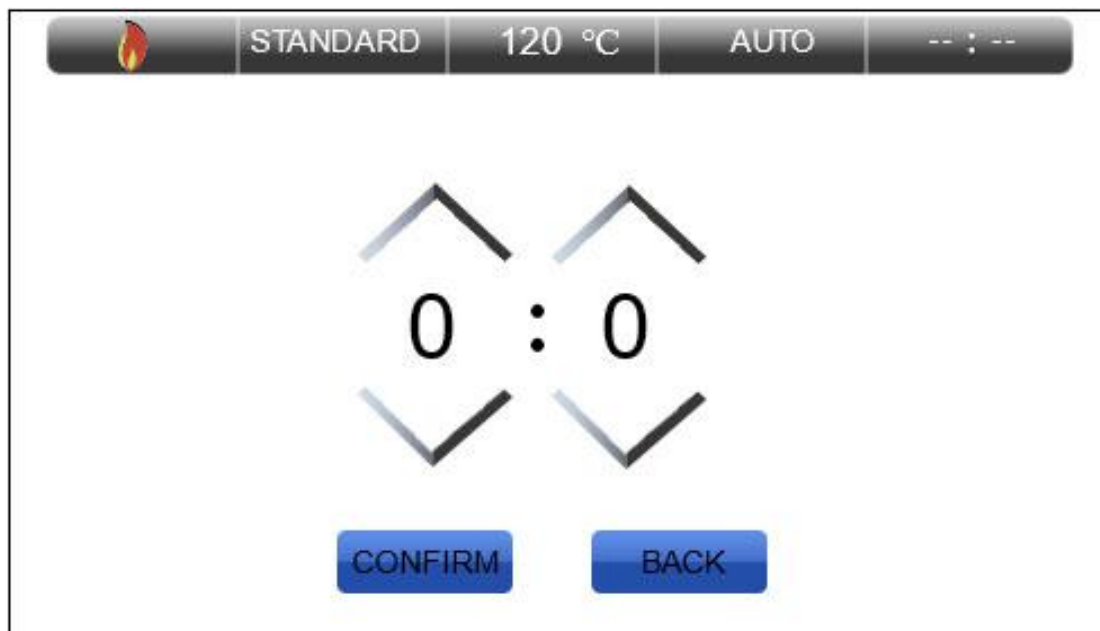

8. After all settings are completed, click “BACK” to return to the home page.



9. Place an empty sample pan on the sample pan holder and ensure it is laid flat.

10. Close the heater cover and tare by clicking the “TARE” icon.

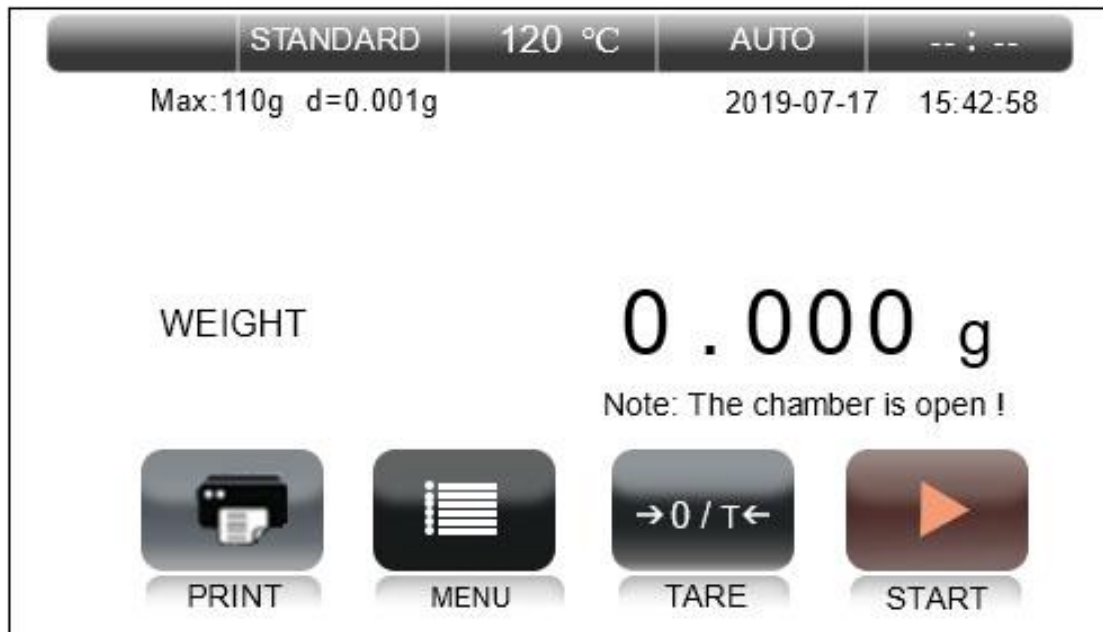

11. Open the heater cover and place the sample evenly on the sample pan.

12. Close the heater cover and start drying by clicking “START”.



* During the drying process, the current temperature, time and temporary results will be continuously updated and displayed.

13. When the drying is completed, an audible signal will sound and the result will be displayed.



14. Click the “CONVERSION” icon to switch to different displays of results.



15. Open the heater cover and use the sample pan handle to remove the sample pan.

7. Maintenance

- Turn off the power switch and remove power cord during maintenance.
- Cool down all parts of the analyzer before maintenance.

7.1 Cleaning

Make sure that no dust or liquid enters the moisture analyzer housing.

Do not use any aggressive cleaning agents (solvents, abrasive cleaning agents, etc.) or organic solvents to clean the analyzer.

Clean the moisture analyzer using a piece of lint-free cloth which has been wet with a mild detergent (soap) only.

7.1.1 Cleaning the sample chamber

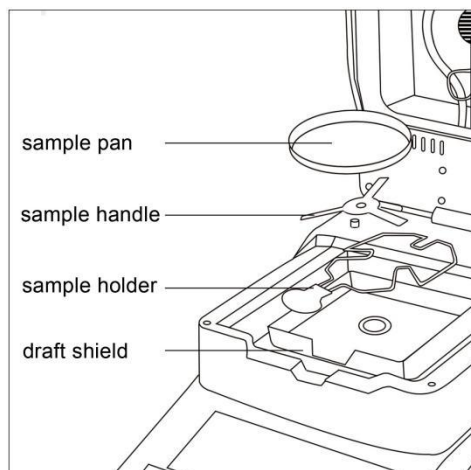

Remove sample pan, sample handle, sample holder and draft shield for cleaning. Ensure that no liquid seeps into the device. Dry with a dry soft cloth after cleaning.

7.1.2 Cleaning the heating unit

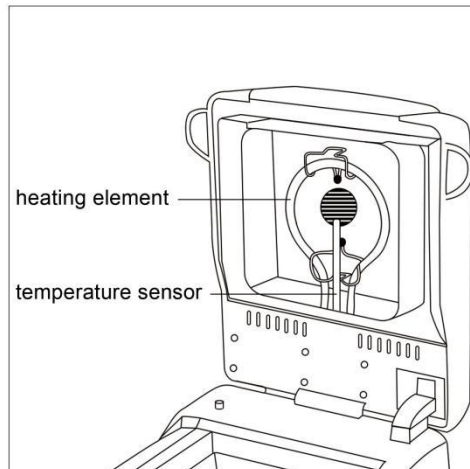

Disconnect the power by unplugging power cord from the outlet.

- Carefully remove any residue from the temperature sensor.
- Use a damp, lint-free cloth to clean the tubular heating element.

7.1.3 Cleaning the display panel and keyboard

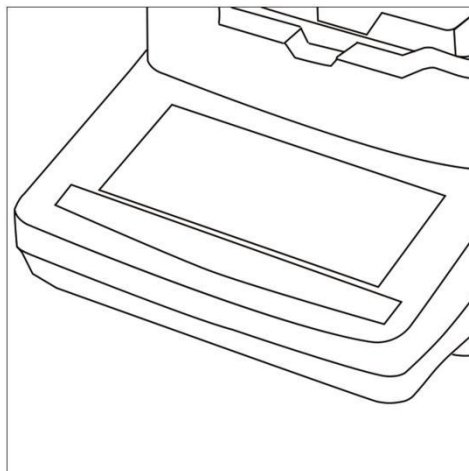

Wipe the panel with a damp cloth. Do not use a chemical dust cloth, as it may damage the paint surface and display panel.

7.2 Disposal

Disposal of equipment and packaging must be carried out by the operator in accordance with relevant laws of the country or region in which the equipment is to be used.

8. Troubleshooting

Problem: Display remains off after switching on.

Possible causes:

- Power cord is not connected
- Power line fuse blown
- Power supply interrupted
- Instrument faulty

Problem: Display does not change when loading samples.

Possible causes:

- The sample pan/pan holder is not installed correctly.

Problem: Weight display is constantly changing or unstable.

Possible causes:

- The sample pan is in contact with the draft shield or heating chamber
- Air movement
- Test bench vibration
- Electromagnetic field interference

Problem: Drying does not start

Possible causes:

- Heating chamber open
- Power cord is not connected
- Power line fuse blown

Problem: Measurement takes too long.

Possible causes:

- Incorrect ending mode selected

Problem: Measurements are not repeatable.

Possible causes:

- The samples are not homogeneous.
- Drying time is too short.
- The temperature selected is too high and the sample has been oxidized.
- The temperature sensor is contaminated or defective.
- The sample is not completely dry.

9. Technical Data

Model	USS-HMA03
Capacity	110g
Readability	0.001g / 0.01%
Heating Element	Halogen lamp
Temperature range	104°F - 390.2°F (40°C - 199°C)
Time setting range	1 - 99 min
Drying mode	Standard, Fast, Soft
Ending mode	Auto, Timing, Manual
Displays of results	[%m] moisture content [%] dry content [g] residual weight in grams
Adjustment	External calibration weight - 100g
Display panel type	Touch screen
Pan size	φ 90 mm
Interface	RS-232
Power	110V 60Hz AC
Dimensions	240×365×180 mm
Net weight	4.9kg
Shipping weight	7.1kg