

WG600F Industrial Intelligent Dispensing Peristaltic Pump Operation Manual

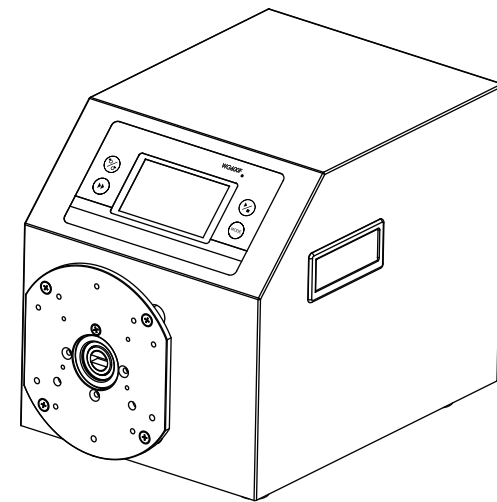

Safety Precautions



Important information:

Be sure to read the manual carefully before operation!

	This icon warns: Keep fingers away from moving parts.
	This icon warns: Be careful.
	This icon warns: Be careful, the surface is hot.
	This icon warns: Be careful, electric shock hazard.
	This icon warns: To recycle this product.
	This icon warns: Personal protective equipment (PPE) must be worn.

Danger:

	Please use the same power supply as that on the nameplate of the machine, otherwise the equipment will be damaged!
	Do not disassemble the shell or modify the interior of the equipment by yourself, otherwise it may cause malfunctions or even electric shock accidents!
	When installing and disassembling the pump tube, please turn off the power first and do not approach the rotating roller to prevent fingers and clothing from getting entangled in the mechanical mechanism!
	When installing and disassembling external control devices, please turn off the power first to prevent electric shock accidents or damage to the equipment!

Input Analog Specifications		
Project	Parameter	
Interface Principle		
Input Impedance (<100HZ)	0-5V	R1=4KΩ
	0-10V	R1=4KΩ
	4-20mA	R1=248Ω
Allowable Error	0-5V、0-10V、4-20mA	±1%
Resolution	0-5V	5mV
	0-10V	10mV
	4-20mA	16uA
Internal Output Power Specifications		
Project	Parameter	
The Output Voltage	DC12V ± 1V	
Allowable Output Current	< 130mA	
External Input Power Specification		
Project	Parameter	
Allowable Input Voltage	DC5-25V	
Allowable Input Current	> 350mA	

Disclaimer

We believe that the information contained in this document is correct, but if it contains any errors, Baoding Enterprise Technology Co., Ltd. is not responsible and reserves the right to modify the relevant technical specifications without prior notice.







Note: This product is not medically certified. When used as a component in a medical device, the medical device itself must have medical certification.

Data version: V1.2

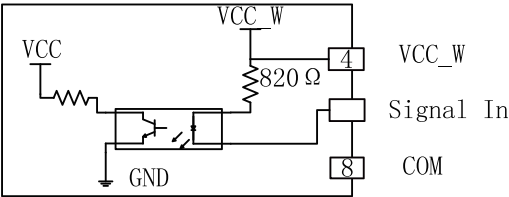
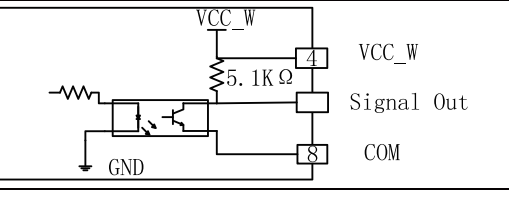



While the product is improving, the manual information may be changed without notice.

External Control Input and Output Performance

Input Switch Value or OC Gate Specification	
Project	Parameter
Input Interface Principle	
Single Signal Input ON Current	$5.5\text{mA} < I_{on} < 15\text{mA}$
Single Signal Input OFF current	$I_{off} < 1.5\text{mA}$
Signal Input Method	switch (closed, open) or NPN transistor OC gate
External Control Input Voltage	5V
	12V
	24V
Input loop requires no series resistors	
Isolation Method	Optoelectronic isolation
Output Specification	
Project	Parameter
Principle of Output Interface	
Output Method	NPN transistor OC gate with internal pull-up
Isolation Method	Optoelectronic isolation

	The grounding plug must be well grounded at all times, otherwise there is a risk of electric shock, electromagnetic interference, or induced static electricity!
	If it is used to transport dangerous liquids, special operating procedures must be developed for this liquid, and personnel must also be prevented from being injured during using.
	This product is not suitable for explosion-proof environment, and it should not be used in explosive environment.

Warning:

	Before using, please confirm that the transmitted liquid will not react chemically with the tube or pump head, otherwise it will damage the tube or pump head. If unsure, please consult our engineers.
	The tube is a vulnerable part, please check it regularly. Our company is not responsible for the loss caused by tube damage, especially the leakage of toxic, harmful and valuable liquids!
	Due to the fact that the actual working environment conditions (including temperature, humidity, acid, alkali, organic solvent and other corrosive environment, dust environment, power supply voltage, etc.) exceed our technical specifications and the machine is damaged, our company is responsible for the paid warranty, which is not within the scope of normal warranty.
	The primary protection for the operator against injury from the moving parts of the pump is provided by the pump head safety device. Please note that safety devices vary from product to product, depending on the model of pump head. See pump head section in manual.
	If the pump was running before the power failure, the pump will automatically start when the power is turned back on.

Contents

Peristaltic Pump Introduction -----	1
Description -----	1
Applications -----	2
Functions and Features -----	2
Components and Interfaces -----	4
Display Panel and Operating Keypad -----	5
Keypad -----	5
Icon Description -----	6
Touch Screen -----	7
Status Bar -----	7
Operating Zone -----	11
Navigation Keys -----	11
External Control Interface -----	26
Installation Instructions -----	27
Before Operation -----	27
Install Pump Head and Tube -----	28
Power Connection -----	28
Operation Instructions -----	29
First Run Wizard -----	29
Flow Calibration -----	30
Working Mode -----	33
External Control Mode -----	38
Communication Mode -----	41
Foot Switch Mode -----	44
Equipment Network Distribution -----	45
Equipment Online Upgrade -----	48
Malfunction and Maintenance -----	50
Warranty and After-sales -----	50
Drive Spare Parts -----	50

◆ Flow Rate Chart of the Pump

Drive Model	Suitable Pump Heads	Channel Number	Suitable tube (mm)	Single-channel Flow Rate(L/min)
WG600F	YZ35	1	73# 82#	0.0013 ~ 13.2
	2×YZ35	2	73# 82#	0.0013 ~ 13.2



Note: The above Suitable pump head, the number of suitable channels and the flow rate of a single channel are all obtained from the test of purified water with a Enterprise tube under normal temperature and pressure conditions in the laboratory. This data is for reference only. Due to pressure in actual use, temperature, medium characteristics, tube material and other specific factors, the specific situation needs to consult our engineers.

◆ Suitable Pump Heads for Peristaltic Pump Drives



YZ35

Technical Parameters

WG600F Technical Parameters

Functions

Suitable Pump Heads	YZ35
Functions	Key control start and stop, direction, full speed, state memory (power-off memory). Foot switch control, external control start and stop, external control direction, with physical isolation, 5V/12V/24V,5V-24V wide range input, 0-5V/ 0-10V/4-20mA software setting switch. Flow mode, time dispensing mode.
Communication	S485, MODBUS, WI-FI remote control.
Display	Color LCD touch screen.
Direction Control	Free adjustment of forward and reverse rotation direction.

Performance

Flow Range	0.0013-13.2L/min
Speed Range	0.1-600 rpm
Speed Resolution	0.1 rpm, accuracy error less than ±0.2%
Adjustment Method	Mask key, touch screen operation
Display Method	65565 LCD
Applicable Power Supply	AC 100-240V 50Hz/ 60Hz
Wattage	<400W
Working environment	Temperature 0- 40°C Relative humidity<80%
Dimensions	361×233×269 mm
Drive Weight	10.2kg
Degree of Protection	IP31
Degree of Pollution	2

Daily Maintenance-----	50
Maintenance Worksheet -----	51
Malfunction Solutions -----	52
Dimensions-----	53
Ordering Information-----	53
Optional Accessories Table -----	53
Naming Rules-----	54
Technical Parameters-----	55
Flow Rate Chart of the Pump-----	56
Suitable Pump Heads for Peristaltic Pump Drives -----	56
External Control Input and Output Performance-----	57
Disclaimer -----	58

Peristaltic Pump Introduction

Peristaltic pump is a safe and reliable fluid transmission equipment, the fluid only contacts with the inner wall of the tube line, through squeeze the tube to realize the fluid transmission.

Its unique no-valve, no-seal, tube line-integrated transmission design, Ensure the cleanliness of the fluid, reduce the risk of leakage, and make the fluid more reliable, safe and clean way of transmission.

Working Principle

The tube fits between the roller and the pressure block, forming a seal at the point of contact when squeezed. As the roller rotates and advances along the tube, the sealing contact advances with it. As the rollers pass, the tube returns to its original shape, creating a vacuum that draws in liquid. Before the roller reaches the end of the pressure block, a second roller starts compressing the tube at the beginning of the pressure block, isolating the fluid between the two compression points. As the first roller clears the pressure block, the second roller continues to expel the liquid through the discharge port of the tube. At the same time, a new partial vacuum is created behind the second roller, sucking in more liquid from the inlet. There is no backflow and siphoning, and the pump effectively seals the tube when not in use, so there is no need for a separate valve.

Description

This peristaltic pump adopts color LCD display, touch screen operation, intuitive and convenient. Four working modes: flow mode, volume dispensing mode, time dispensing mode and programming mode, to adapt to different work requirements. Brushless servo motor drive, strong torque, maintenance-free. Standard communication protocol, more convenient control. Stainless steel shell, easy to clean, corrosion-resistant.

WG600F flow range: 0.0013-13.2L/min, speed range: 0.1-600rpm.

Naming Rules

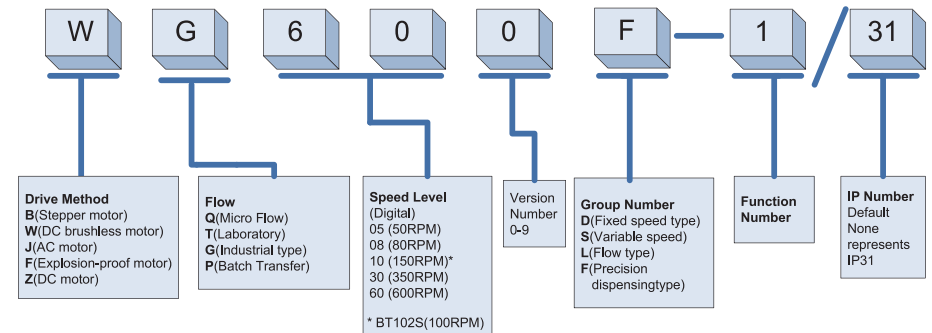



Note: There are no parts in the pump that can be repaired by the user. If the user repairs by himself, the warranty of the pump will be invalid. If there is a fault that cannot be solved after checking the software and connecting the external hardware, please contact the Enterprise, and do not repair by yourself.

Dimensions

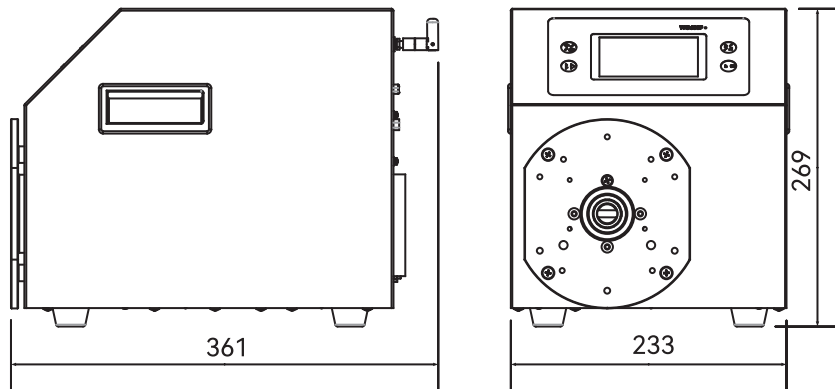

Figure 71 Dimensions

Ordering Information

Product Model	Description	Order Number
WG600F		

Table 8 Ordering Information

Optional Accessories Table

Accessories List	Description	Order Number
Foot switch		1060200100017

Table 9 Table of Optional Accessories

Applications

- The pump body does not touch the liquid.
- No valve blockage.
- The inner surface is smooth and easy to clean.
- The suction lift can reach up to 8 meters of water column.
- Low shear force, can be used to transfer emulsions or liquids containing foam, cells, etc.
- Suitable for transporting liquids containing gases, magnetic beads, or suspensions containing small particles.
- It is suitable for precise transmission and quantitative dosing, and can achieve a certain accuracy by choosing appropriate tube diameter and filling efficiency.
- Suitable for transferring liquids with a certain degree of viscosity;
- The liquid only comes into contact with the tube
- If use food and medical grade tube, this pump can be used for food and medical transmission and filling.
- Replacement tube of special material to transfer abrasive liquids.

Functions and Features

- Color LCD display, touch screen increase key operation.
- It has four working modes: volume dispensing, time dispensing, flow mode and program mode.
- Five groups of dispensing parameters can be pre-stored in volume dispensing mode and time dispensing mode.
- Program mode can pre-store 30 groups of dispensing parameters.
- It has the functions of start and stop, forward and reverse rotating, full speed, speed regulation, state memory (power-off memory), etc.
- It has the functions of flow display, flow rate control, liquid volume accumulation and flow calibration.
- The speed resolution is 0.1 rpm, and the speed accuracy error is less than $\pm 0.2\%$.
- Brushless servo drive, high torque, high efficiency, maintenance-free.
- Peristaltic pump expert system, wizard prompts operation, more convenient.
- Intelligent temperature control function to minimize the noise of peristaltic pump.

- Support WIFI communication, after the device is connected to the network, you can remotely monitor or control your peristaltic pump through the APP (optional).
- Software settings switch external analog speed regulation mode (0-5V/0-10V/4-20mA), External control signal 5-24V wide range input, control start and stop, forward and reverse rotating, external control signal optoelectronic isolation. RS485 communication, support MODBUS communication protocol, a variety of communication parameters can be set, and convenient to connect with various control devices.
- The circuit board is sprayed with conformal coating to achieve the effect of dustproof and moistureproof.
- Super anti-interference characteristics, wide voltage design, suitable for complex power supply environment.
- The 304 stainless steel shell is easy to clean and effectively protects against the corrosion of various acids, alkalis, salts and organic solvents.
- Large torque output, two pump heads can be installed to realize different combinations of pump heads and drives.
- Optional foot switch for dispensing filling function.

◆ Malfunction Solutions

NO.	Malfunction Type	Malfunction Description	Solutions
1	Hardware	No display	<ol style="list-style-type: none"> 1. Check whether the power cord is connected properly. 2. Check whether the fuse is blown. If it is blown, please contact the manufacturer for replacement.
2	Hardware	Motor does not rotate	<ol style="list-style-type: none"> 1. Check whether the flow or speed is set too small, such as 0.1rpm.
3	Hardware	Motor is trembling	<ol style="list-style-type: none"> 1. Check that the pump head screws and plate rod are tightened.
4	Hardware	The motor rotates in only one direction	<ol style="list-style-type: none"> 1. Check that the direction keys are working normally. 2. Check whether the external control direction signal is normal.
5	Hardware	The key does not work	<ol style="list-style-type: none"> 1. Whether or not it is locked.
6	Hardware	Noisy when the pump is running	<ol style="list-style-type: none"> 1. Around 70 rpm and 120 rpm, it belongs to the resonance frequency of the motor, and it is normal for the sound to be loud. 2. Check that the pump head screws and plate rod are tightened.
7	Hardware/ Software	Communication does not work	<p>First check the software:</p> <ol style="list-style-type: none"> 1. Whether the mode is communication. 2. Reset the machine address. 3. Check if there are two machines on the bus with the same address. <p>If the problem is not resolved, continue to check the hardware:</p> <ol style="list-style-type: none"> 4. Check if the connection is correct. 5. Check whether the external control power supply supplies power.
8	Hardware/ Software	External control does not work	<p>First check the software:</p> <ol style="list-style-type: none"> 1. Whether the mode is external control. <p>If the problem is not resolved, continue to check the hardware:</p> <ol style="list-style-type: none"> 2. Check if the connection is correct. 3. Check whether the external control power supply supplies power.
9	Hardware/ Software	Inaccurate flow rate display	<ol style="list-style-type: none"> 1. Calibrate the flow rate.

Table 7 Malfunction Solutions Reference Table



Note: This product is not medically certified. When used as a component in a medical device, the medical device itself must have medical certification.



Note: Always disconnect the pump from the mains power before opening the pump head cover to change tubes, or performing any assembly, disassembly or maintenance activities.

◆ Maintenance Worksheet

Regular maintenance of the pump according to the maintenance schedule will help reduce damage to pump components and ensure personal and property safety.

Maintenance Tasks	Frequency	Actions after exception
Check if the pump leaks and damage.	1. Check before starting each time. 2. Daily visual inspection. 3. Periodic inspection during pump operation.	1. Before operating the pump, repair leaks and damage. 2. Replace parts when necessary. 3. Clean up all spilled liquid.
Check for abnormal temperature or noise during pump operation.	1. Daily visual inspection. 2. Periodic inspection during pump operation.	Check and replace worn parts.
Do you need to replace the tube	1. Check the condition of tube at most every three days	Please replace the tube in the following situations: 1. When the flow rate is lower than 75% of the original value. 2. When the tube has burst and is badly worn. 3. When the user-defined replacement cycle is reached.
Check pump head and rotor assembly.	1. Regularly check the wheel flexibility every week. 2. Check when replacing tube. 3. Once a year complete inspection for wear and tear, check bearing clearance and function.	1. Worn and damaged surfaces can lead to premature tube failure, replace worn parts in a timely manner.

Table 6 Maintenance Work List

Components and Interfaces

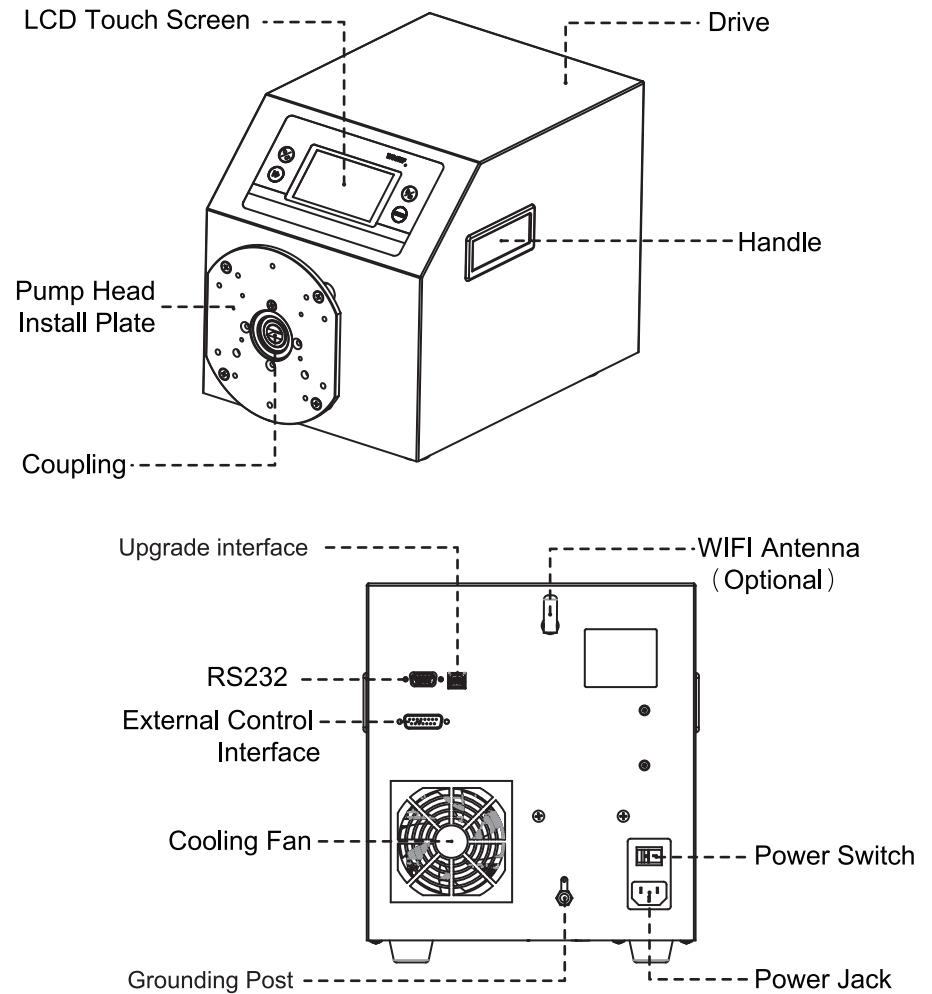

Figure 1 Components and Interfaces

Display Panel and Operating Keypad

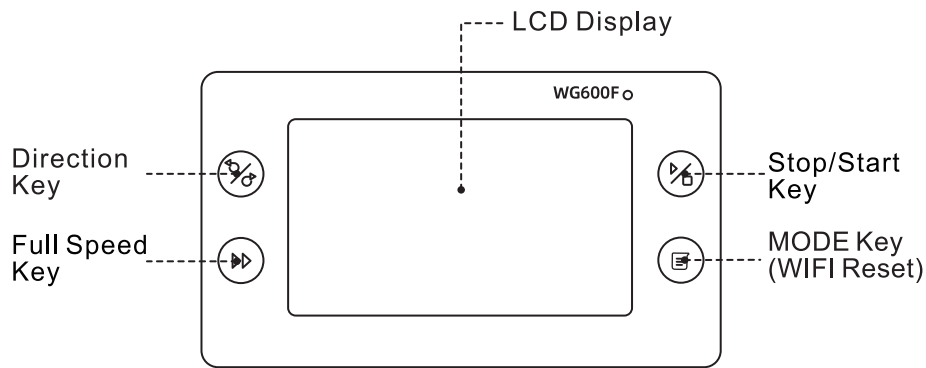





Figure 2 Display Panel

◆ Keypad

-  **Start /Stop Key:** Control the start and stop of the pump.
-  **Direction Keys:** Control the direction of pump operation, switch between forward (clockwise) and reverse (counterclockwise).
-  **Full Speed Key:** The pump runs at maximum speed and is used for filling or emptying liquid.
-  **MODE Key.** In the main interface, when the machine is in the stop state, it will enter the interface for choosing the working mode. when it is in an interface other than the main interface, press the key to return to the previous interface.

Malfunction and Maintenance

◆ Warranty and After-sales

- **WG600Fseries peristaltic pump have three-year free warranty**
 1. The warranty scope only for the whole driver of WG600F peristaltic pump, Pump head, tube and other consumables are not within the scope of this warranty.
 2. The warranty period counts form the date of purchase shown on the customer's valid purchase certification.
 3. In the warranty period, Enterprise is responsible for the repair and replacement free of charge.
 4. This warranty does not cover the damage that caused by human factors such as water, fall, improper use, but Enterprise will repair free, only charge the cost of material fees.

● Special Instructions

Please check the model specifications before using tubes and other consumable products. Please Note that once unpacked and used, returns and exchanges are no longer accepted unless there are quality problems.

◆ Drive Spare Parts

Spare parts	Model	Spare part number
Blown fuses	1A	3020200100004
Power cable	250V 10A	3022300200016

◆ Daily Maintenance

- Peristaltic pump routine maintenance can refer to the following table.
- There is a cooling fan behind the peristaltic pump, please do not cover it to avoid affecting heat dissipation.
- Peristaltic pumps can not be flushed with water, if the pump tube rupture during operation, the liquid in the pump head should be dried or dried in time.
- Do not use chemical solvents to clean the peristaltic pump and pump head surface.

- Waiting for the completion of the firmware package download, the device will prompt "upgrade complete", and automatically return to the operating interface, at this time, the user has completed the online upgrade of the drive firmware, check the firmware version information, it will be prompted "currently the latest version".

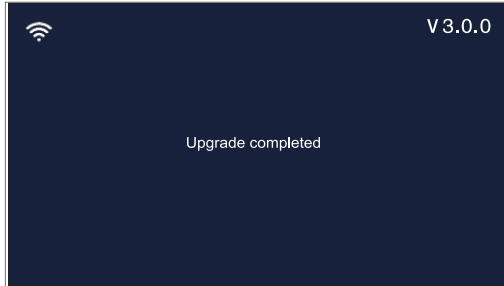

Figure 69 Firmware Upgrade Completed

- Please ensure that the device will not be powered off during the upgrade process, otherwise the upgrade will fail. After the upgrade fails, you can reboot and upgrade again via the APP.

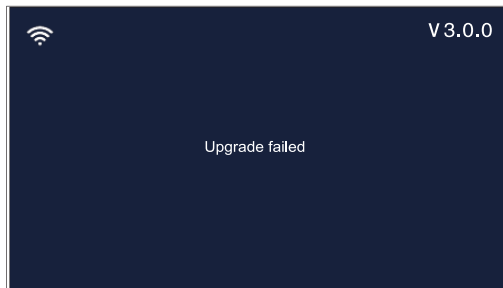

Figure 70 Firmware Upgrade Failed

◆ Icon Description

Icon	Function	Icon	Function
	Tone on/off		Locked/Unlocked
	Internal control mode		Foot switch mode
	Current mode		Voltage mode
	Communication Connected		Communication Disconnected
	Direction of rotation		Start/Stop
	WIFI connected/disconnected		WIFI connect LAN
	Mode setting		Already configured, connecting
	Quick setup		Preview mode
	System menu		Calibration wizard
	Back to previous step/previous page		Exit mode
	Enter key		Go to the next step/next page
	Decrease key		Increase key

Table 1 Description of Display Icons

◆ Touch Screen

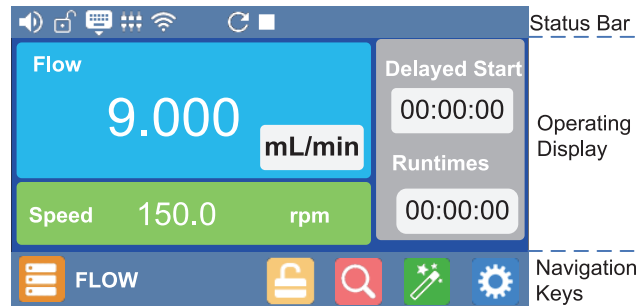

Figure 3 Touch Screen

◆ Status Bar

A. **Tone State:** Display the current prompt tone and key tone on or

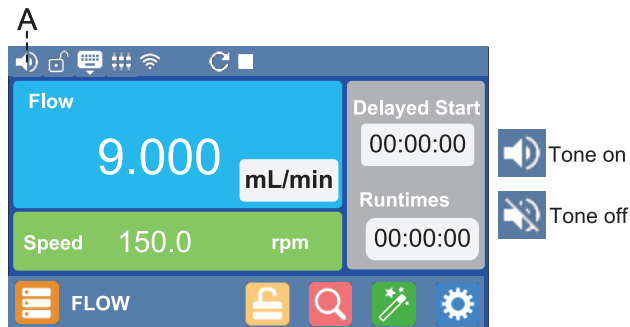

Figure 4 Tone State Icon

B. **Locked.** Displays the current locked state. When the device is locked, the control mode and system parameters cannot be modified.

- Please confirm whether the WIFI password is entered correctly.
- Please make sure the WIFI connection is on the 2.4G WIFI band, if not, please change to a 2.4G band network
- After the above is confirmed, retry again, if it still fails, please contact us.

Equipment Online Upgrade

The WIFI version of the peristaltic pump supports online upgrade of the firmware.

- When there is a new version of the firmware for the drive, the user can open the Enterprise Cloud Pump APP, follow the prompts to operate on the mobile phone, and click "Online Upgrade".
- At this point, the drive will enter the ready-to-upgrade interface.



Figure 67 Firmware Ready to Upgrade

- After about 3 seconds, the drive will enter the online upgrade interface.

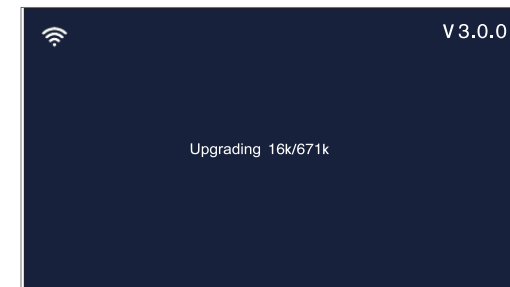

Figure 68 Firmware Online Upgrade in Progress

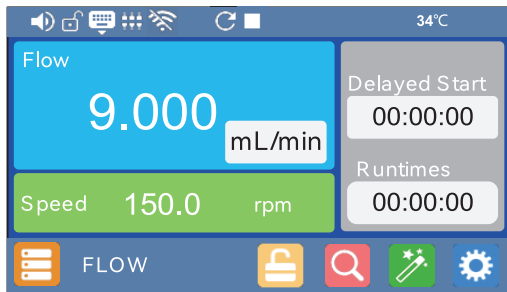

Figure 65 Drive Pending Network Distribution State

- At this time, open the Enterprise Cloud Pump APP, enter the home page, click the + sign in the upper right corner, choose [Add Device], and enter the add device page. At this time, you should be able to automatically search for the device to be distributed, click [Add] and follow the APP prompts to add it.

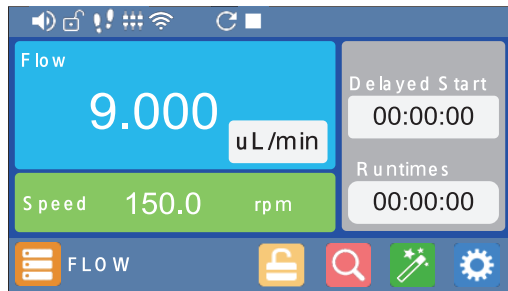

Figure 66 Drive Completed Network Distribution

- Once added successfully users can control the drive using the Enterprise Cloud Pump APP.

If the distribution fails, troubleshoot the following problems and try again:

- Please confirm whether the device is in the network distribution state (the WIFI state icon flashes quickly, 3 times per second)
- Please confirm whether the mobile phone has turned on the blue tooth and geographic location permissions, and authorized to the APP.
- Please confirm whether the network environment is unobstructed, and keep mobile phones, devices, and WIFI devices as close as possible

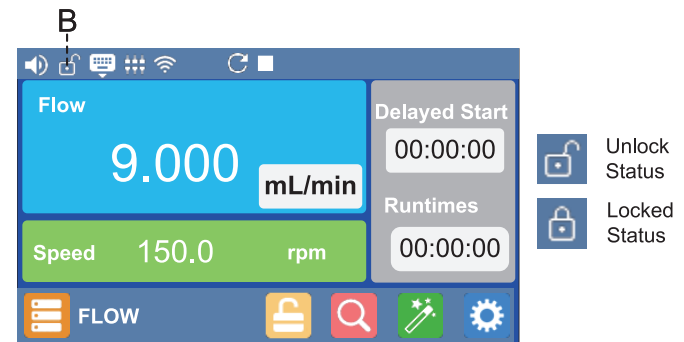

Figure 5 Locked and Unlocked Icons

C. Control Mode. Display the current control mode, there are four modes, as shown in Figure 6:

- Internal Control Mode:** The operation of the pump is controlled by keys and touch screen.
- Foot Switch Mode:** The start and stop of the pump is controlled by the foot switch, and other parameters are controlled by keys and touch screen.
- Current Mode:** The flow of the pump is controlled by an external analog 4-20mA, the start and stop and direction are controlled by an external signal, and the key does not work.
- Voltage Mode:** The flow of the pump is controlled by an external analog 0-5V or 0-10V, the start/stop and direction are controlled by an external signal, and the key does not work.

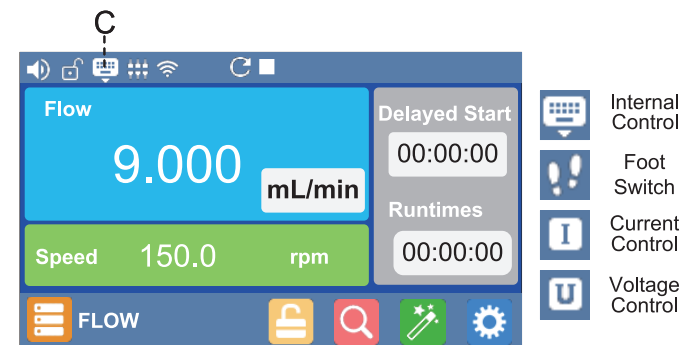

Figure 6 Control Mode

D. Communication State: Display whether the current communication is connected, as shown in the figure below:

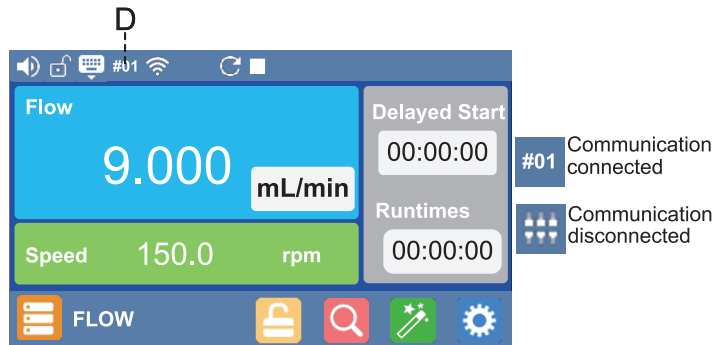

Figure 7 Communication State Icon

E. WIFI State: As shown below

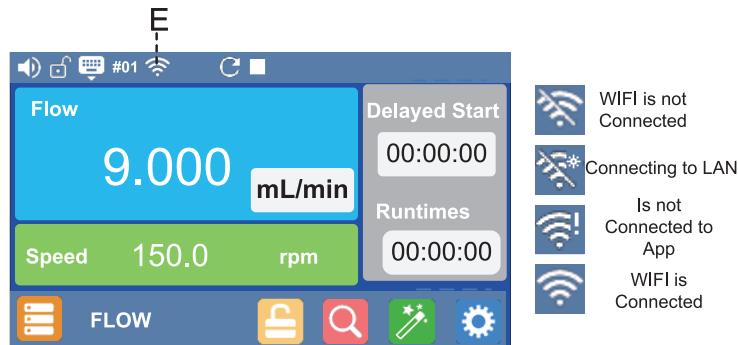

Figure 8 WIFI State Display

Currently available on the app store include (subject to change without notice):

- 1) Android domestic: Myapp, Huawei, VIVO, OPPO, Xiaomi
- 2) Android Abroad: Google
- 3) iOS: Apple App Store.

② New User Registration and Login

After downloading and installing the app, follow the instructions to complete registration and login.



③ After entering the APP, there will be an authorization application for Bluetooth permission and access to geographic location permission. Please follow the prompts to allow the use.

④ Make sure your phone is connected to a WIFI network that supports the 2.4G band.

⑤ Make sure that the mobile phone, device, and router are close together.

2. Network distribution

- Make the device enter the standby network distribution state: In the main interface of any working mode, press and hold the "" key for 10 seconds until the screen WIFI state icon starts to flash and a "beep" sounds, and the device enters the standby network distribution state for 3 minutes.

WG600F Peristaltic Pump Operation Manual

- Turn on the power switch and the screen display the main control interface.
- In internal control mode, volume dispensing mode, time dispensing mode, and program mode. Connect and then disconnect the switch of foot switch, the pump will begin to dispense.
- In foot switch mode, the external control mode is level. Connect the switch of the foot switch, the pump will run. Disconnect it, the pump will stop.
- In the foot switch mode, the external control mode is pulse. Connect and then disconnect the switch of foot switch, the pump will run, and do that again, the pump will stop.

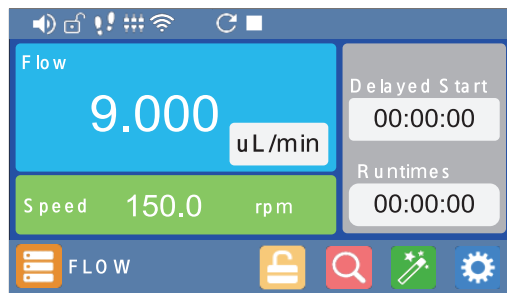

Figure 64 Foot Switch Interface

Equipment Network Distribution

1. Network distribution preparation

① Download App

Search for "Enterprise Cloud Pump" in the APP store or scan the QR code below with your mobile browser to download and install.



F. Direction of Rotation: Displays the current direction the pump is running. The icon is displayed in the stop state as shown below:

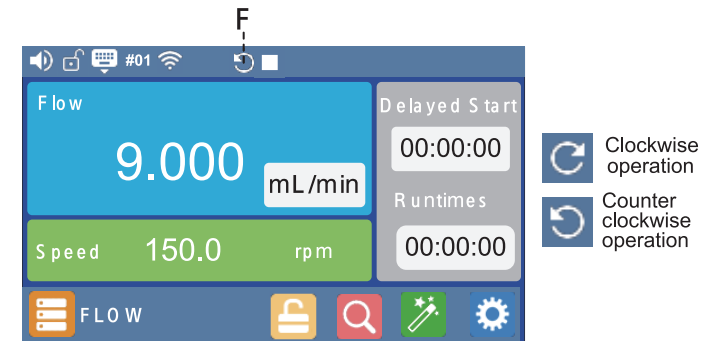

Figure 9 When the Pump Stops Running Counterclockwise

In the running state, the orange ring displays the current running direction in animation, as shown in the figure below:

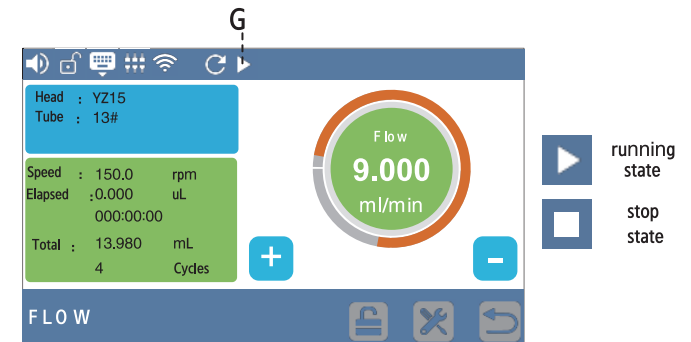

Figure 10 When the Pump is Running Clockwise

G. Running State: The icon indicates the current running state.

H. Temperature Display: Display the current internal temperature of the drive, as shown in Figure 10 above, the current temperature of the drive is 34°C.

◆ **Operating Zone**

A. Numerical Input Setting: In the stop state, you can click the numerical value, and directly input the numerical value to be modified in the pop-up dialog box, pay attention to the numerical range and unit on the dialog.

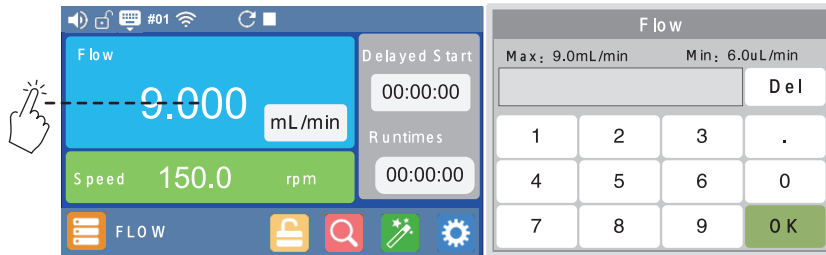

Figure 11 Value Input Box

! Note: If the flow rate needs to be displayed accurately, flow must be calibrated!

B. Unit Setting: In the stop state, click the unit key to pop up a dialog box, choose the unit to be the figure below is to set the flow unit:

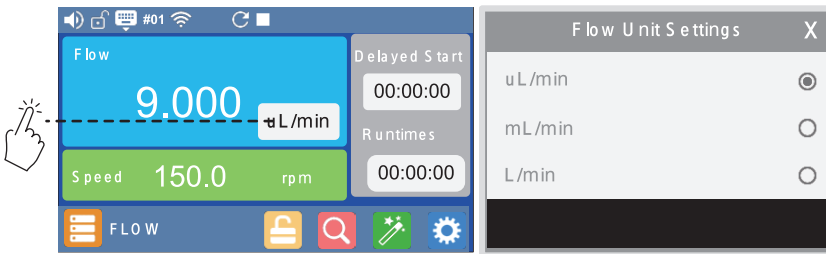

Figure 12 Unit Choose Box

◆ **Navigation Keys**

Mode Setting: Set the specific control parameters in different working modes. Turn on/off the prompt sound. Locked/Unlocked

◆ **Foot Switch Mode**

• Turn off the power switch, connect the circuit according to the wiring diagram below, and connect the DB15 interface to the back interface of the pump.

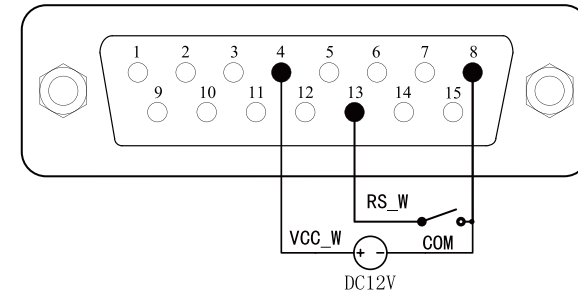

Figure 62 Foot Switch External Power Supply Wiring Diagram

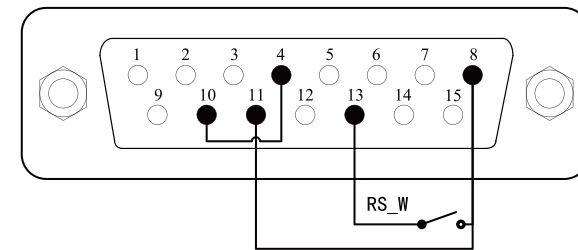

Figure 63 Foot Switch Internal Power Supply Wiring Diagram

! Note: Do not connect power to the external control connector. Please provide the correct signals according to the legend pins. Do not exceed the range specified by the signal value. Do not connect the supply voltage across other pins. Otherwise it may cause permanent damage and will not be covered by the warranty.

! Note: Low voltage signals must be isolated from mains power. Use a separate shielded ground input wire.

! Note: Use a qualified protective wire sleeve at the end of the multi-strand cable, otherwise there will be a risk of damage to the equipment.

WG600F Peristaltic Pump Operation Manual

- Turn on the power switch and the screen display the main control interface.

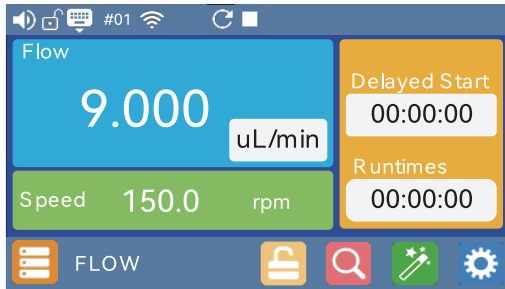

Figure 60 Communication Connected Interface

- In internal control mode, the status bar displays the pump number (as #01), which indicates communication connected, otherwise, the communication disconnected.
- Peristaltic pump through the RS485 communication, the default setting for the communication rate of 9600, data bits 8 bits, parity bit even parity, stop bit 1 bit. Communication parameters can be modified in the communication settings of common parameters, as shown in the figure below.

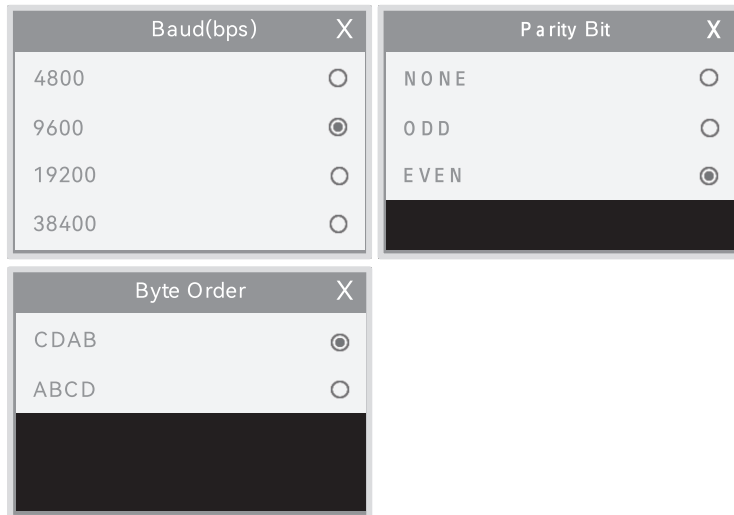
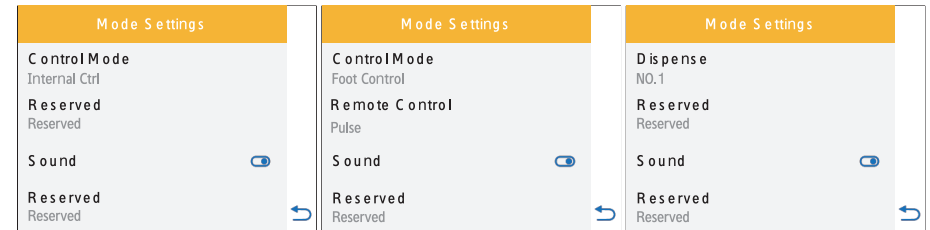
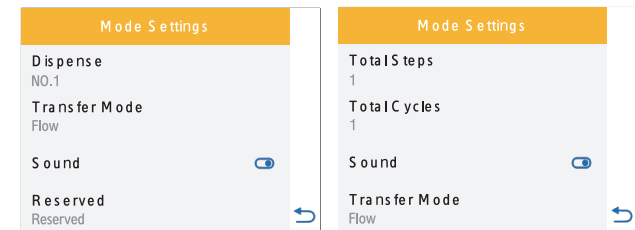

Figure 61 Communication Setting Interface

- After successful connection, the pump functions are controlled by communication commands.



Flow-Internal Control Mode Flow-External Control Mode Volume Dispensing Mode



Time Dispensing Mode Program Mode

Figure 13 Mode Setting Interface

- 🔍 **Preview Mode:** Check the running state and parameter changes. The current operating parameters are displayed on the left side of the interface, and the operating state is displayed on the right side.

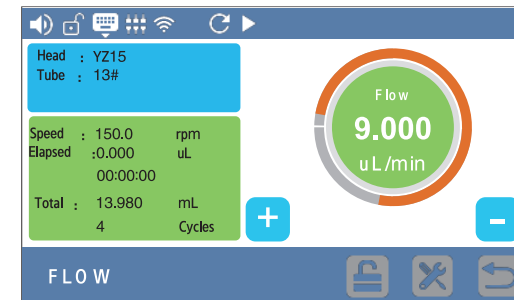

Figure 14 Preview Interface

WG600F Peristaltic Pump Operation Manual

In the flow mode, orange means stop state, green means running state, and yellow means pause state As shown below:

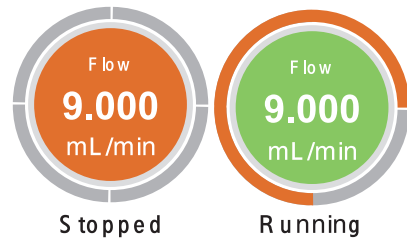

Figure 15 Running State Indication

In the running state, the rotating direction of the ring indicates the running direction of the pump, as shown in the figure below, if it changes sequentially from left to right, it means clockwise running. If it changes from right to left, it is running counterclockwise.

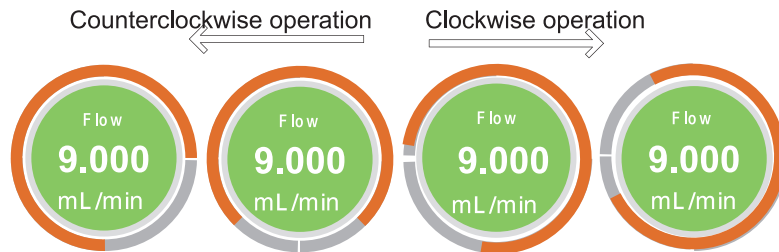

Figure 16 Running Direction Indication

In the dispensing mode, orange means stop state, green means running state, and yellow means pause state.

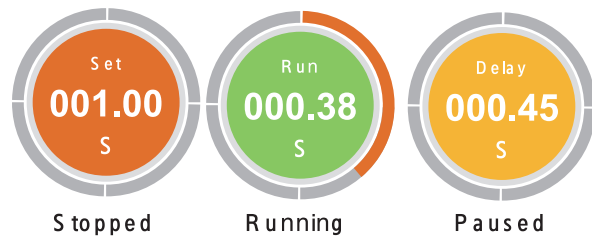

Figure 17 Dispensing State Indication

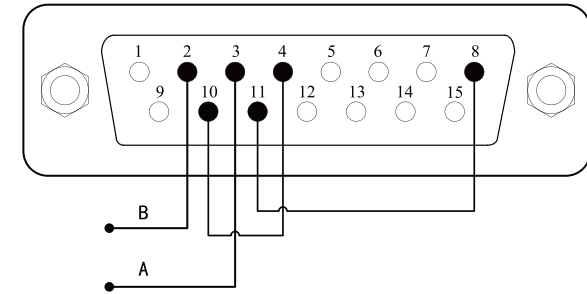

Figure 59 Communication Internal Power Supply Wiring Diagram

	<p>Note: Do not connect power to the external control connector. Please provide the correct signals according to the legend pins. Do not exceed the range specified by the signal value. Do not connect the supply voltage across other pins. Otherwise it may cause permanent damage and will not be covered by the warranty.</p>
	<p>Note: Low voltage signals must be isolated from mains power. Use a separate shielded ground input wire.</p>
	<p>Note: Use a qualified protective wire sleeve at the end of the multi-strand cable, otherwise there will be a risk of damage to the equipment.</p>

of analog quantity. Connect and then disconnect the switch of external RS_W again, and the pump will stop running.

- The external control mode can be set in the common parameters. When the direction of external control is in level mode, disconnecting the CW_W switch, the pump operates in clockwise direction, connecting the CW_W switch, the pump operates in counterclockwise direction. When the external control mode is pulse mode, connect and then disconnect the CW_W switch once, and the pump will run clockwise, connect and then disconnect the CW_W switch again, and the pump will run counterclockwise.

◆ **Communication Mode**

RS485 communication supports MODBUS protocol, which can control various functions of the pump. For specific parameter addresses and support instructions, refer to the communication technical standard of Enterprise.

- Turn off the power switch, connect the circuit according to the wiring diagram below, and connect the DB15 interface to the back interface of the pump.

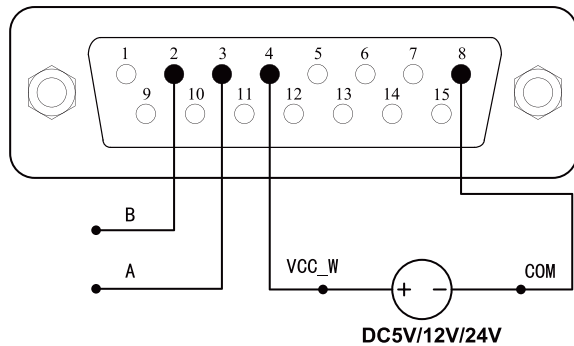

Figure 58 Communication External Power Supply Wiring Diagram



Quick Setting: Can reset the accumulated liquid volume and accumulated times, turn on/off the prompt sound, lock/unlock.

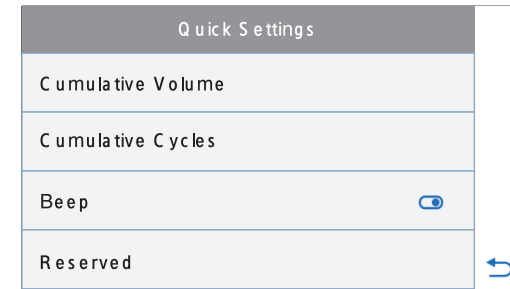

Figure 18 Quick Setting Interface

Fine-tuning Key: In the preview interface of the flow mode, adjust the flow in real time. Click the increase icon to increase the flow by one minimum unit. Click the decrease icon to decrease the flow by one minimum unit. Press and hold the increase icon or decrease icon for 1 second, and continue to press the key, and the flow rate will increase or decrease rapidly. As shown below:

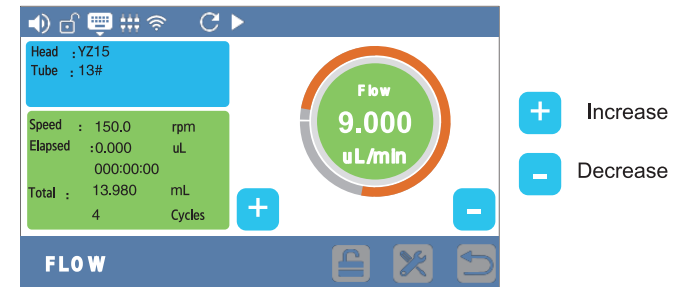

Figure 19 Fine-tuning Key



Calibration Wizard: In order to improve the flow accuracy of the liquid transmission, it is necessary to calibrate the flow. According to the prompt of the wizard, use the balance or graduated cylinder to weigh the transmission liquid, so that the displayed value corresponds to the actual flow rate accurately.



Note: If the flow rate needs to be displayed accurately, flow must be calibrated! See flow calibration on page P27 for details.

System Menu: In the stop state, press the system menu icon to enter the main control interface, the interface is as follows:

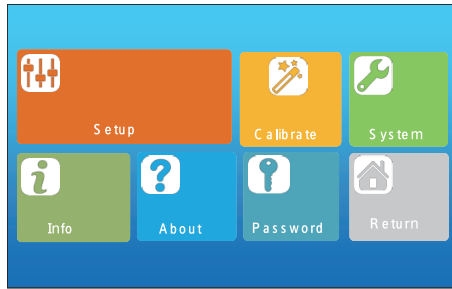

Figure 20 System Menu Interface

Common Parameter: Set the common parameters of the peristaltic pump, and view the menu by sliding up and down on the touch screen, as shown in the figure below:

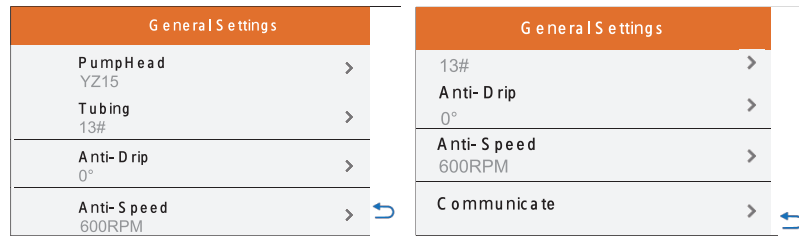

Figure 21 General Parameter Interface

Pump Head Setting: According to the actual condition, choose the suitable pump head model, and view other options by sliding up and down on the touch screen.

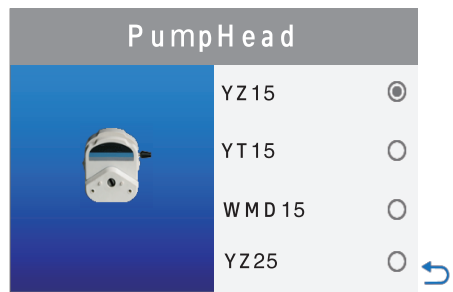
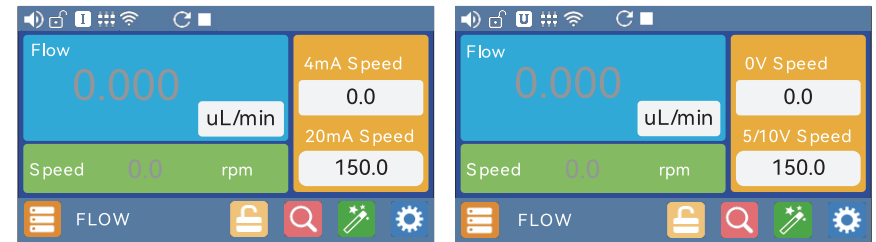

Figure 22 Pump Head Setting Interface

- Turn on the power switch and the screen displays the main control interface
- Press the MODE key to choose the flow mode.
- Click Mode Setting icon to enter the menu, click control mode to choose Voltage Mode or Current Mode.



Current Mode

Voltage Mode

Figure 56 Analog Control Interface

- Click External Start/Stop to choose whether the external control signal to control the pump start/stop is level or pulse

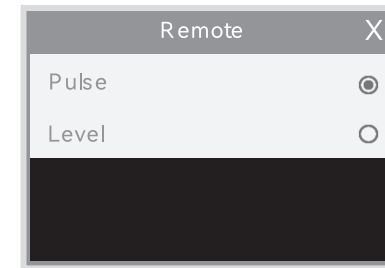

Figure 57 External Control start/stop Choose Interface

- When the external control start/stop in the mode setting is level mode, connect the switch of external RS_W, open the analog power supply, and the pump will change its speed with the change of analog quantity. Disconnect the switch of external RS_W, and the pump will stop running. When the external control start/stop in the mode setting is pulse mode, connect and then disconnect the switch of external RS_W for, open the analog power supply, and the pump will change its speed with the change

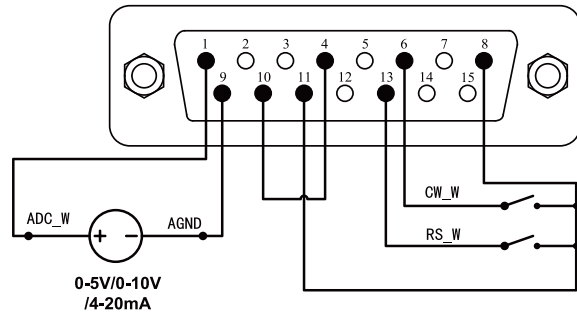

Figure 55 Wiring Diagram for Connecting Internal Power Supply in External Control Mode



Note: Do not connect power to the external control connector. Please provide the correct signals according to the legend pins. Do not exceed the range specified by the signal value. Do not connect the supply voltage across other pins. Otherwise it may cause permanent damage and will not be covered by the warranty.



Note: Low voltage signals must be isolated from mains power. Use a separate shielded ground input wire.



Note: Use a qualified protective wire sleeve at the end of the multi-strand cable, otherwise there will be a risk of damage to the equipment.



Note: When DG and DT10 pump heads are chosen, the system defaults to limit the maximum speed to 100 rpm.

- **Tube Setting:** According to the actual condition, choose the suitable tube model, and swipe up and down on the touch screen to view other options.

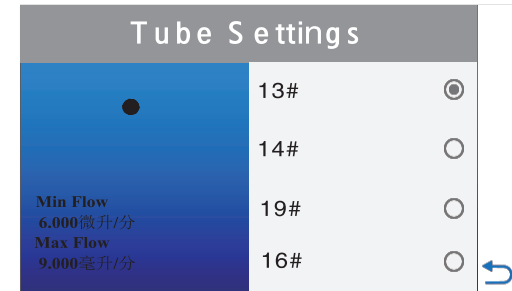

Figure 23 Tube Setting Interface



Note: Each pump head corresponds to a series of suitable tubes, please choose the suitable pump head and tube!

- **Anti-drip Setting:** When the peristaltic pump stops, in order to prevent the liquid in the tube line from dripping, the motor of the peristaltic pump rotates in the opposite direction for an angle to suck back the liquid in the tube line. Click the anti-drip setting key to adjust the reverse angle. When the angle is set to 0, this function is off.

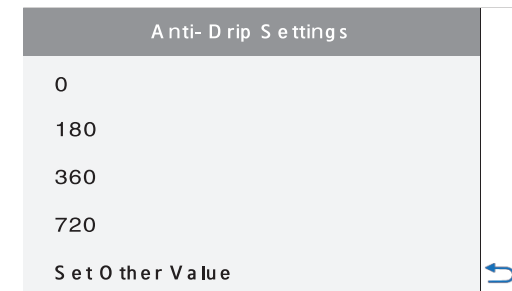

Figure 24 Anti-drip Setting Interface

- **Reverse Speed:** According to the actual condition, set the speed of pump back-suction.

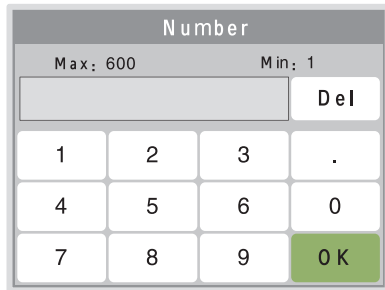

Figure 25 Reverse Speed Interface

- **Communication Setting:** Set the parameters of RS485 communication, as shown in the figure below:

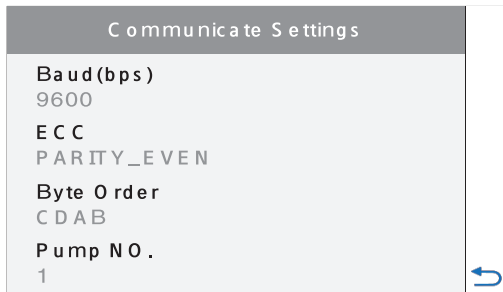

Figure 26 Communication Setting Interface

- **Advanced Settings:** After entering the correct user password (default is blank) in the password input interface, enter the common parameters again to view more parameter settings, and view the menu by sliding up and down on the touch screen.

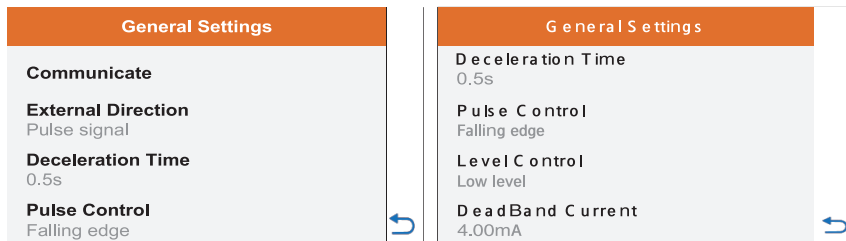

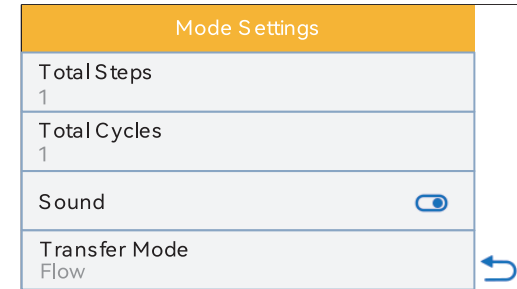

Figure 27 Advanced Setting Interface

Click  mode setting icon to set the total steps and the total number of cycles in the interface.



◆ External Control Mode

The speed is controlled by the external input mode analog quantity, the start/stop and direction are controlled by the external signal. Front panel keys do not work.

- When the power is cut off, connect the circuit according to figure 52 or figure 53, and connect the DB15 interface to the back interface of the pump.

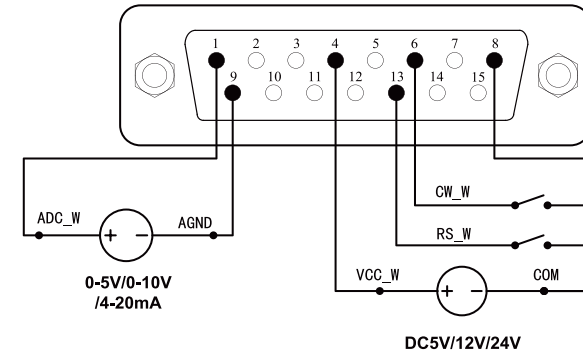

Figure 54 Wiring Diagram for Connecting External Power Supply in External Control Mode

• **Program Mode**

By setting the number of steps and cycles to run, the pump automatically completes each of the set steps.

The preview interface displays the current model of pump head and tube, current run time, cumulative fluid volume and times

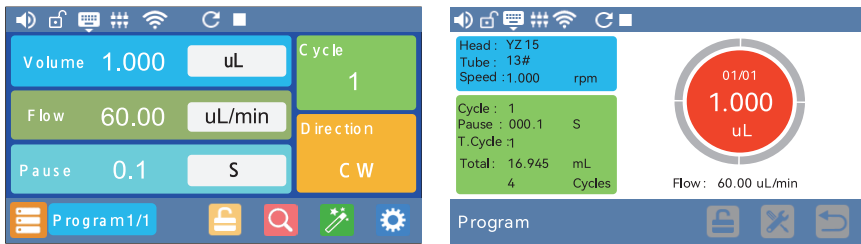

Figure 53 Program Mode Interface

Liquid volume: volume of liquid to be dispensed(uL, mL or L).

Flow Rate: Flow rate during dispensing(μ L/min, mL/min or L/min).

Time: the flow rate used for dispensing(hours, minutes or seconds).

Interval Time: Time for intermediate stops in multiple dispensing(hours, minutes or seconds).

Cycle: Number of dispensing. When the number of dispensing is 1, the pump runs only once, and the interval time is invalid. When the number of dispensing is greater than 1, the pump runs to the set number of times and automatically enters the next step.

Direction: The direction the pump runs when dispensing, clockwise or counterclockwise can be chosen.

- **External Control Direction:** Choose the external control rotation direction signal is level mode or pulse mode. The level mode means that the external control signal controls the running direction of the pump by maintaining the high and low level signals. The pulse mode means that the external control signal controls the operation of the pump by detecting the rising edge/falling edge generated when switching between high and low levels Direction, e.g. controlled by a unlock key (effective in external control mode).

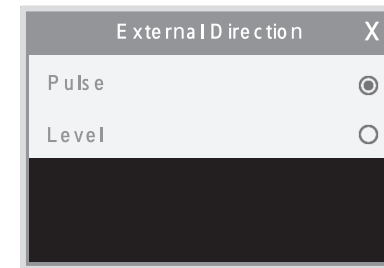

Figure 28 External Control Mode Interface

- **Deceleration Time:** Refers to the time from when the pump receives the stop signal to when the pump stops rotating. The problem of splashing during liquid filling can be reduced by modifying this parameter.

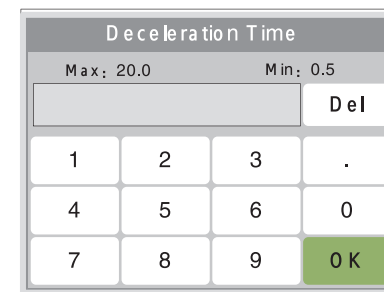

Figure 29 Deceleration Time Interface

- **Pulse Signal:** When the external control signal is a pulse signal, the falling edge or rising edge is valid through options. The falling edge refers to the transition from high level to low level, and the rising edge

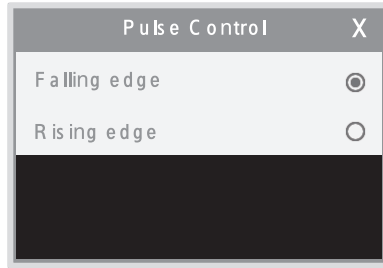

Figure 30 Pulse Signal Interface

- **Level Signal:** When the external control signal is a level signal, you can choose whether it is active at low level or high level through the option.



Figure 31 Level Signal Interface

- **Calibration Wizard:** In order to improve the flow accuracy of the liquid transmission, it is necessary to calibrate the flow. According to the prompt of the wizard, use the balance or graduated cylinder to weigh the transmission liquid, so that the displayed value corresponds to the actual flow rate accurately.

Note: If the flow rate needs to be displayed accurately, flow must be calibrated!

• **Time Dispensing Mode**

By setting the running time and flow rate, the pump automatically calculates the liquid volume for dispensing.

The preview interface displays the model of the current pump head tube, the current running time, the accumulated liquid volume and the number of times, as shown in the figure below:

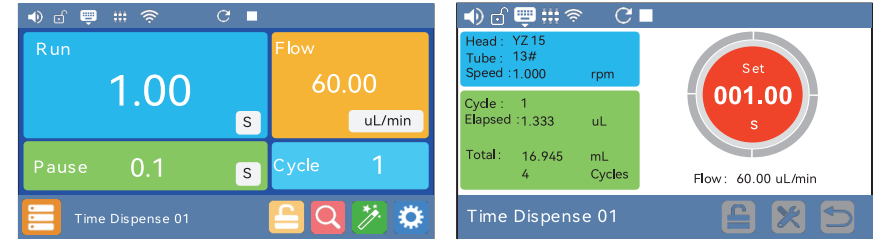

Figure 52 Time Dispensing Interface

Running: the time to be dispensing.

Flow Rate: flow rate during dispensing(uL/min or mL/min).

Interval Time: Time for intermediate stops in multiple dispensing(hours, minutes or seconds).

Cycle: number of dispensing. When the number of dispensing is 0, the pump will run cyclically and will not stop until the start/stop key is pressed. When the number of dispensing is 1, the pump will run only once, and the interval time will be invalid. When the number of dispensing is greater than 1, the pump will run to the number of times it is set to run, and it will stop automatically.

Click Mode Setting icon to choose different group numbers in the interface, and five groups can be pre-stored.

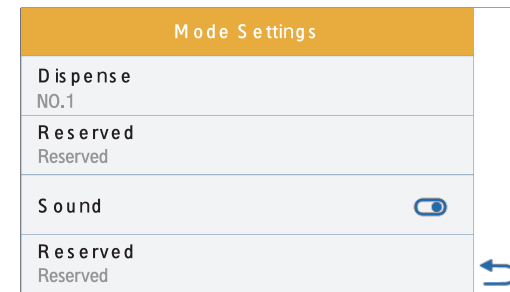

WG600F Peristaltic Pump Operation Manual

The preview interface displays the model of the current pump head tube, the current running time, the accumulated liquid volume and the number of times, as shown in the figure below:

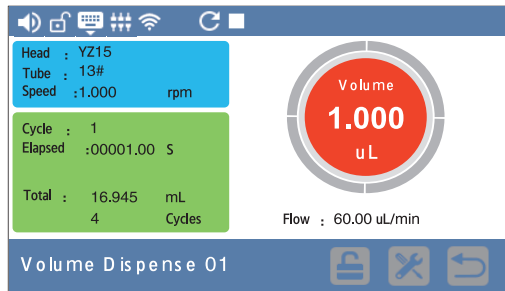

The parameters that can be set in the main interface are as follows:

Liquid Volume: volume of liquid to be dispensed(uL, mL or L).

Flow Rate: Flow rate during dispensing(μ L/min, mL/min or L/min).

Time: Time used for dispensing (hours, minutes or seconds).

Interval Time: the time between dispensing. the unit of interval time in multiple dispensing (hour, minute or second).

Cycle: number of dispensing when the number of dispensing is 0, the pump will run cyclically and will not stop until the start/stop key is pressed. When the number of dispensing is 1, the pump will run only once, and the interval time will be invalid. when the number of dispensing is greater than 1, the pump will run to the number of times it is set to run, and it will stop automatically.

Click Mode Setting icon  to choose different group numbers in the interface, and five groups can be pre-stored.

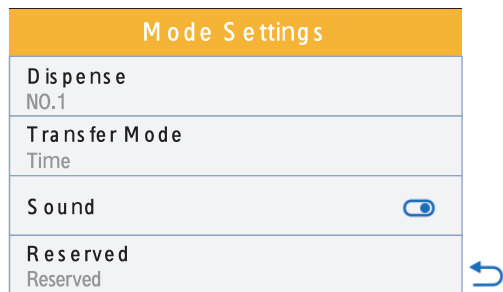

■ **System Parameters:** Set the system parameters of the peristaltic pump, and view the menu by sliding up and down on the touch screen, as follows:

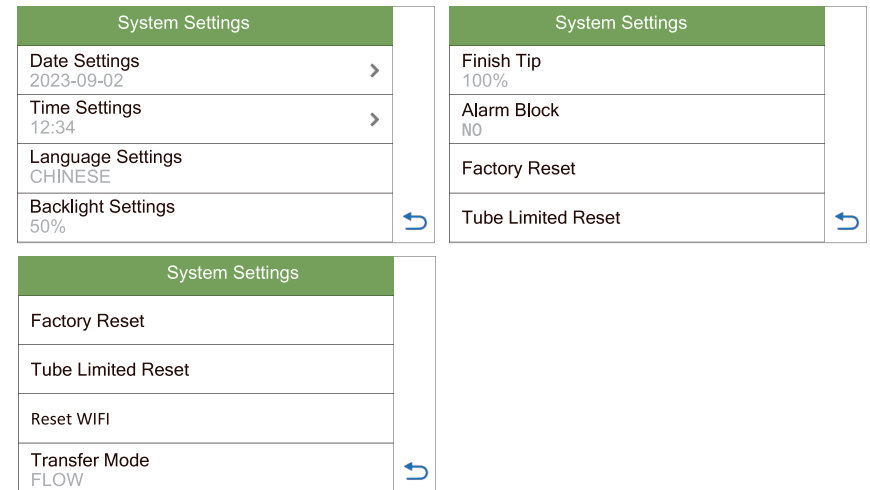

Figure 32 System Parameter Interface

- **Date Setting:** Set the current year, month, and day, choose the year and month with the left and right keys, then touch the screen to manually choose the date, and finally press the exit key to automatically save the date just set.

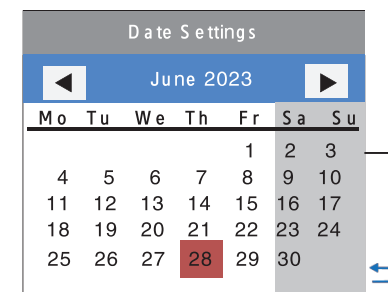

Figure 33 Date Setting Interface

- **Time Setting:** Set the current hour, minute and second, set it by pressing the up and down keys, and finally press the exit key to automatically save the time just set.

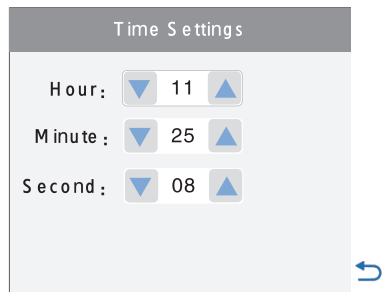

Figure 34 Time Setting Interface

- **Language Setting:** Choose the language used, Chinese or English.



Figure 35 Language Setting Interface

- **Backlight Setting:** Set the brightness of the LCD screen (1%-100%).
- **Reminder of Dispensing Completion:** In the "liquid volume dispensing mode" and "program mode", when the last working step is completed, the percentage (0%-100%) set by the user will be reminded when it is completed. In the networked state, the reminder will be sent to the user through the APP. The default is 0, that is, the reminder of the completion of the dispensing is turned off.
- **Motor Loss Speed Alarm:** When a stalled rotor occurs during the operation of the device, the drive will automatically stop running, and it is turned off by default.
- **Restore default value:** Restore all parameters to factory default value, need to restart the drive to take effect. You can also press and hold the direction key and the mode key at the same time after turning off the power to turn on the power, and the main interface will be displayed normally after the



Figure 49 Timing Time Setting Interface

- Then click the start and stop key, start the delay start process, and there will be an alarm clock symbol in the status bar, as shown in the figure below.

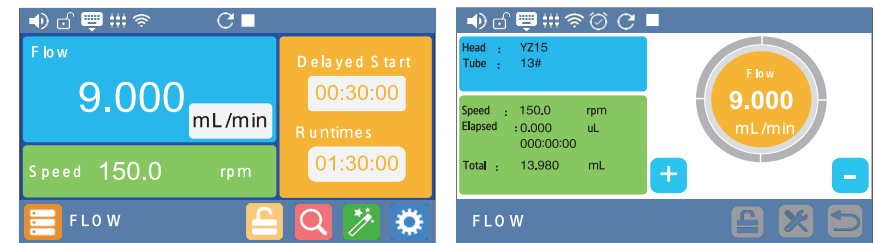
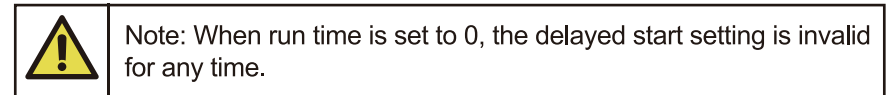

Figure 50 Timing on State Icon

- **Volume Dispensing Mode**
By setting the liquid volume and flow rate, the pump automatically calculates the dispensing time for dispensing. The transmission mode can be switched to time mode in the mode setting menu as shown below:

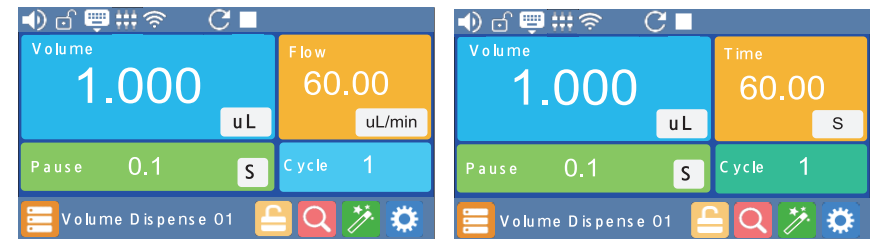

Figure 51 Volume Dispensing Interface

◆ **Working Mode**

In the main interface and in the stop state, press the MODE key to enter the working mode interface, as shown in the figure below:

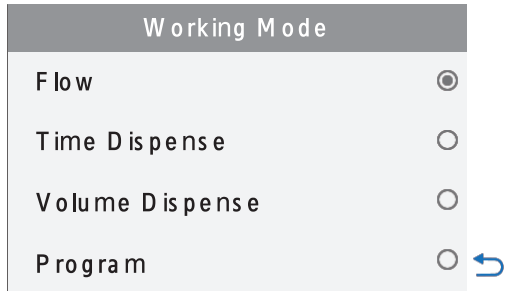

Figure 47 Working Mode Interface

• **Flow Mode**

The pump runs continuously according to the set flow rate and records the accumulated liquid volume.

In the main interface, the flow rate and flow unit can be set, and the flow rate can also be changed by setting the speed. In the preview interface, the model of the current pump head and tube, the current running time, and the accumulated liquid volume are displayed, and the flow rate can be fine-tuned by pressing the increase key and decrease key.

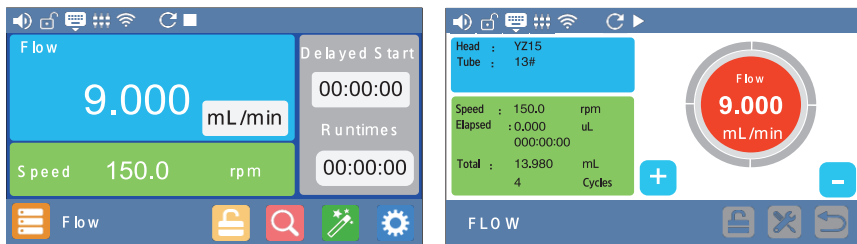

Figure 48 Flow Mode Interface

The functions of delayed start and scheduled stop can be realized in the flow mode. For example, to realize the automatic start with a delay of 30 minutes and the automatic stop after running for 1 hour and 30 minutes after starting, you need to click the time below and set delayed start and run time in the pop-up dialog box.

power is turned on, and the device will be restored to the factory settings.



Figure 36 Restore Default Value Interface

- **Tube Replacement Reminder:** After opening, when the theoretical remaining life of the tube is 0, the Enterprise Cloud Pump APP will send a notification on the mobile phone to remind the user that the tube may be damaged and needs to be replaced in time. it is turned off by default.

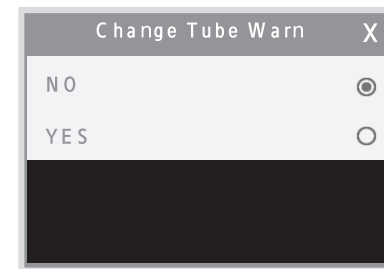

Figure 37 Tube Replacement Reminder Interface

- **Reset Tube Life:** Set the tube life to the initial value, usually after replacing the tube.

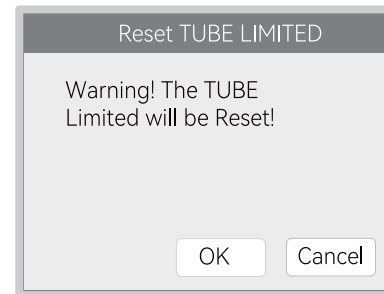

Figure 38 Reset Tube Life Interface

- **Reset WIFI:** After reset, the WIFI binding information will be cleared, and the drive will enter the state of waiting for network distribution. At this time, it can be re-bound (in the main interface of any working mode, press and hold the "MODE" key for 10 seconds to reset).

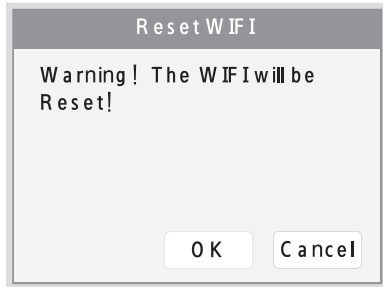

Figure 39 Reset WIFI Interface



Note: The option with*, it is the option of customized version of WIFI version, and the setting of ordinary version is invalid.

- **Transfer Mode Choose:** When liquid volume dispensing mode is chosen, the liquid volume-flow mode or liquid volume-time mode can be chosen to reduce the conversion time of the operator.

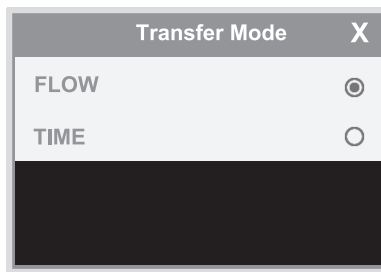

Figure 40 Transfer Mode Choose

- **Information Query:** For the usage information of the peristaltic pump, view it by sliding up and down on the touch screen.

- 7) The system automatically calculates the correction coefficient and displays the reference of the original coefficient. If the deviation is more than double, please pay attention to whether the following aspects are wrong.

- There is an error in the measurement
- The unit of the test value is wrong
- The pump head or tube model is set incorrectly.
- Liquid viscosity is too high
- Use double pump head

Confirm that the correction coefficient is correct, and the system will save the new coefficient by pressing key. Press to re-test, press to return to the system parameter interface without saving the new coefficient.

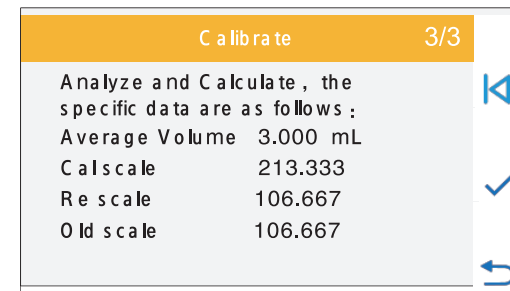

Figure 45 Calculation Result Interface of Calibration Wizard

If no data is entered, it will display as shown in the figure below, please click to retest.

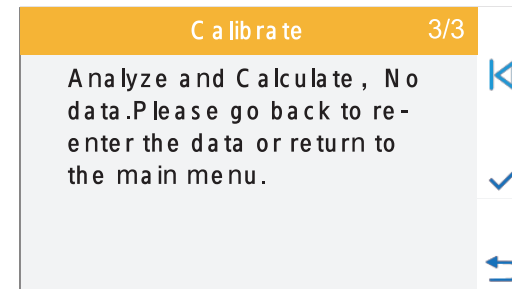

Figure 46 No Data Interface of Calibration Wizard

6) The test interface is as follows:

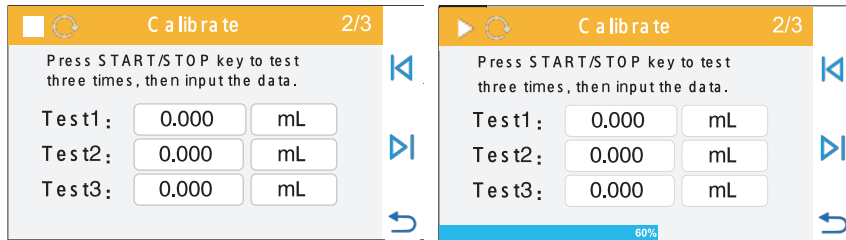

Figure 44 Calibration Wizard Actual Measurement Interface

Note: In order to ensure the test accuracy, it is recommended that the liquid volume value should not be less than the value recommended by the system during flow transmission, and it is recommended that the liquid volume be set to the actual filling volume during liquid volume dispensing.

Prepare the measuring cylinder or beaker, make sure the tube is full of liquid, press start/stop key, the peristaltic pump starts to transfer the liquid, observe the progress bar at the bottom, wait for the peristaltic pump to stop automatically after the transfer is completed, weigh the liquid with a balance or a measuring cylinder, and record measured value. The above process can be repeated to weigh the liquids that have been transferred multiple times, and fill in the values in Test 1, Test 2, and Test 3, pay attention to choose the correct unit, and then click to enter the calibration calculation interface.

If you want to re-modify the test flow and liquid volume, you can click to re-enter the value. Click key to exit the calibration wizard and return to the system parameter interface.

Note: During the test, if there is an accident, you can press the start-stop key to stop the test, and press the start-stop key again to start the test again.

The test value can choose to input one or more sets of data, and the system will automatically calculate the average value.

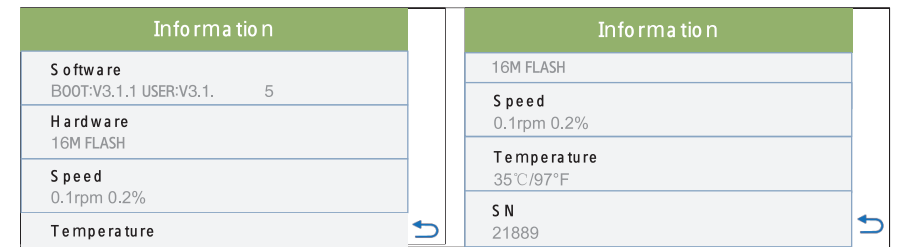

Figure 41 Information Query Interface

■ **Operating Instructions:** Enterprise company's contact information and brief introduction.

■ **Password Setting:** Set the user password, which is used to add/unlock the device, prevent others from modifying parameters, and view more common parameters.

The default password is empty.

In the main control interface, click the mode setting key, click lock, the lock key turns blue to indicate that the device is locked, click the lock again, and the password setting window will pop up, enter the set password, click OK and it will automatically jump to in the main control interface, click the mode setting key again, and you will find that the lock key is gray, which means it is unlocked. If the password is incorrectly, it will still automatically jump to the main control interface. It is necessary to judge whether the device is locked or unlocked by observing the state of the unlock key.

Change Password

The screen is shown in the left picture below when setting a password for the first time. There is no password change key, you need to click OK first, and then it will automatically jump back to the main interface. Enter the password setting interface again, and you will find the change password key in the screen. As shown in the right picture below. Then, enter the password you want to set, and click Change Password key to complete the initial password setting.

The number of digits of the password setting is 1-8 digits, and the specific digits can be freely chosen.

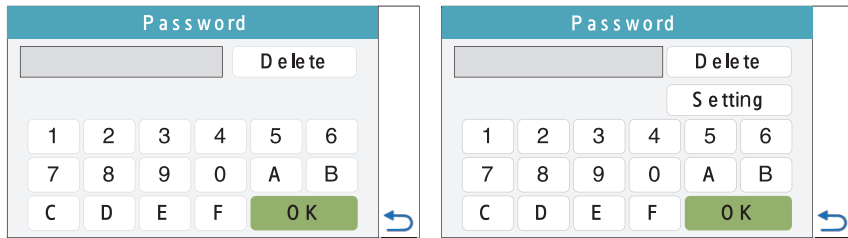

Figure 42 Password Setting Interface

If you forget the password, you need to contact Enterprise to reset or retrieve it.

■ **Return to Main Control:** Return to the main control interface.

◆ Flow Calibration

Weigh the actual transported liquid with a balance or graduated cylinder to calibrate the flow of pump. Calibration must be performed in the following cases.

- First run
- Replace pump head
- Replace tube
- Dual pump heads deliver the same liquid
- Reinstall the tube
- Continuous working time is longer

The specific operation is as follows:

- 1) Install the pump head and tube, and prepare a suitable balance or measuring cylinder and measuring cup.
- 2) In the common parameters, "pump head " and "tube Setting" are set to the actual pump head and tube (refer to Figure 22 and Figure 23 in the introduction of common parameters for details).
- 3) Press the full speed key to fill the tube with fluid.
- 4) In the stop state, click the calibration wizard icon or click the system menu parameter setting icon to enter the system parameter setting interface, and click the calibration wizard icon.
- 5) Enter the calibration wizard interface, the system displays the current flow and liquid volume to be calibrated, where the flow rate refers to the speed of the transmission liquid, and the liquid volume refers to the volume of the transmission liquid.

As shown in the figure below, 9.000ml/min is the flow rate to be tested, and 6.000ml is the liquid volume to be tested. These two values and units can be directly clicked to modify, and then click key to enter the test interface. And click key to exit the calibration wizard and return to the system parameter interface.

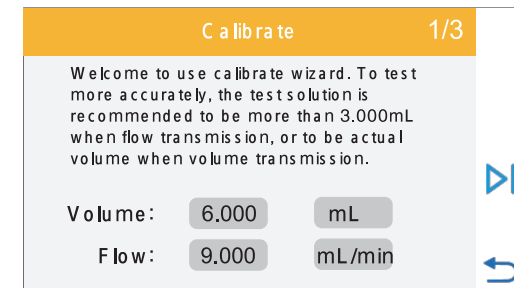

Figure 43 Calibration Wizard Setting Interface

Operation Instructions

◆ First Run Wizard

The pump has preset default operating parameters, as shown in the table below:

Parameter	Default Setting
Language Settings	Chinese
Screen brightness (backlight value)	50%
Password	Blank
Tone	Tone on
Default working mode	Internal Control-Flow Mode
Default volume configuration	13.48mL/min
Default speed	1.0 rpm
Direction of rotation	Clockwise rotation
Delayed start	Closed
Pump head setting	YZ35
Tube settings	73#
Anti-drip setting	Angel O(close)
Reverse speed	600RPM
Communication rate	9600
Parity Check Mode	Even parity
Byte order	CDAB
Pump number setting	1
Direction of external control	Pulse signal
External control signal to control start/stop (foots witch mode)	Pulse signal
External control signal to control start/stop (other external control modes)	Level signal
Deceleration time	0.5 seconds
Pulse signal	Falling edge
Level signal	Low level

Table 4 List of Device Default Parameters

External Control Interface

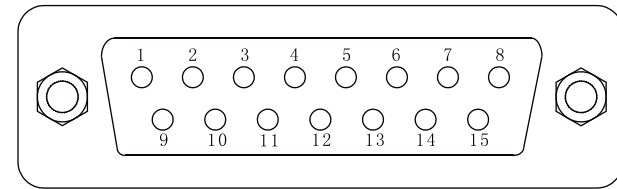

DB15 Pin	English Notes	Description
1	ADC_W	The positive input of the external analog signal
2	B	Communication interface, B pole of RS485
3	A	Communication interface, A pole of RS485
4	VCC_W	External DC power input
5	DAC	Analog voltage signal output
6	CW_W	External input signal to control direction
7	PWM	Pulse signal output
8	COM	External commons
9	AGND	Negative input of external analog signal
10	+12V	Positive of internal +12V power source
11	GND	Ground of Internal power source
12	CW	Internal output to control direction
13	RS_W	External input to control start/stop
14	PWM_W	External pulse signal input
15	RS	Internal output to control start/stop

Table 1 Definition of External Control Pins

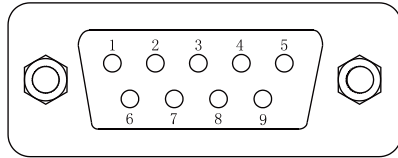

DB9 Pin	English Notes	Description
1		
2	RXD	Receive data
3	TXD	Send data
4		
5	GND	Signal ground line
6		
7		
8		
9		

Table 3 Definition of RS232 Pins

 Note: Do not connect power to the external control connector. Please provide the correct signals according to the legend pins. Do not exceed the range specified by the signal value. Do not connect the supply voltage across other pins. Otherwise it may cause permanent damage and will not be covered by the warranty.

 Note: Low voltage signals must be isolated from mains power. Use a separate shielded ground input wire.

 Note: Use a qualified protective wire sleeve at the end of the multi-strand cable, otherwise there will be a risk of damage to the equipment.

Installation Instructions

◆ Before Operation

- Please compare the packing list to check whether all accessories are wrong or damaged when you open the outer package of the pump. Please contact Enterprise or agent in time, if you find any problems.

- Read the operation manual carefully, and keep it at hand, or keep it in a fixed place for reference at any time.
- Place the pump on a level table with the rear at least 20 cm away from obstacles.

◆ Install Pump Head and Tube

For detailed installation steps, please refer to the operation manual of the corresponding pump head!

YZ35 pump head

Align the flat shaft of the pump head with the groove of the drive coupling and push in. Then turn the pump head so that the screw holes of the pump head are aligned with the screw holes of the pump head bracket of the drive and push in. After fitting the pump head and its bracket, put three fixing screws into the fixing holes of the pump head and tighten them.

◆ Power Connection

The power supply should match the power supply used as indicated by the nameplate on the rear of the case. Plug the supplied power cord into the power socket on the rear of the drive.

 Note: Make sure all power supply wires are rated for equipment wattage.

 Note: The pump must be located so that it can be easily disconnected from the power source when the equipment is in use.

 Note: Please use the same power supply as that on the nameplate of the machine, otherwise the equipment will be damaged!